



HILTI HUS4
MASONRY SCREW ANCHOR
ETA-23/0936 (13.05.2025)



English 2-34
Deutsch 35-67

Public-law institution jointly founded by the federal states and the Federation

European Technical Assessment Body
for construction products



European Technical Assessment

ETA-23/0936
of 13 May 2025

English translation prepared by DIBt - Original version in German language

General Part

Technical Assessment Body issuing the European Technical Assessment:

Deutsches Institut für Bautechnik

Trade name of the construction product

Hilti Betonschraube HUS4

Product family
to which the construction product belongs

Screw anchor for use in masonry

Manufacturer

Hilti AG Liechtenstein
Feldkircherstraße 100
9494 Schaan
FÜRSTENTUM LIECHTENSTEIN

Manufacturing plant

Hilti Werke

This European Technical Assessment
contains

33 pages including 3 annexes which form an integral part
of this assessment.

This European Technical Assessment is
issued in accordance with Regulation (EU)
No 305/2011, on the basis of

EAD 330460-00-0604, edition 08/2022

The European Technical Assessment is issued by the Technical Assessment Body in its official language. Translations of this European Technical Assessment in other languages shall fully correspond to the original issued document and shall be identified as such.

Communication of this European Technical Assessment, including transmission by electronic means, shall be in full. However, partial reproduction may only be made with the written consent of the issuing Technical Assessment Body. Any partial reproduction shall be identified as such.

This European Technical Assessment may be withdrawn by the issuing Technical Assessment Body, in particular pursuant to information by the Commission in accordance with Article 25(3) of Regulation (EU) No 305/2011.

Specific Part

1 Technical description of the product

The Hilti screw anchor HUS4 is an anchor in size 8, and 10 mm made of galvanized or multilayer coating carbon steel. The anchor is screwed into a predrilled cylindrical drill hole. The special thread of the anchor cuts an internal thread into the member while setting. The anchorage is characterized by mechanical interlock in the special thread.

The product description is given in Annex A.

2 Specification of the intended use in accordance with the applicable European Assessment Document

The performances given in Section 3 are only valid if the anchor is used in compliance with the specifications and conditions given in Annex B.

The verifications and assessment methods on which this European Technical Assessment is based lead to the assumption of a working life of the anchors of at least 50 years. The indications given on the working life cannot be interpreted as a guarantee given by the producer, but are to be regarded only as a means for choosing the right products in relation to the expected economically reasonable working life of the works.

3 Performance of the product and references to the methods used for its assessment

3.1 Mechanical resistance and stability (BWR 1)

Essential characteristic	Performance
Characteristic resistance to steel failure of a single screw anchor under tension loading	$N_{Rk,s}$ see Annex C1
Characteristic resistance to steel failure of a single screw anchor under shear loading	$V_{Rk,s}$ [kN], $M_{Rk,s}^0$ see Annex C1
Characteristic resistance to pull-out failure or brick breakout failure of a single screw anchor under tension loading	$N_{Rk,p}$, $N_{Rk,b}$, $N_{Rk,p,c}$, $N_{Rk,b,c}$ see Annex B7, C3, C7, C11, C15 $\alpha_{j,N}$ see Annex C3, C7, C11, C15
Characteristic resistance to local brick failure and brick edge failure of a single screw anchor under shear loading	$V_{Rk,b,II}$, $V_{Rk,b,\perp}$, $V_{Rk,c,II}$, $V_{Rk,c,\perp}$ see Annex B7, C3, C7, C11, C15 $\alpha_{j,VII}$, $\alpha_{j,V\perp}$ see Annex C3, C7, C11, C15
Characteristic resistance to brick breakout failure of a screw anchor group under tension loading	N_{Rk}^g see Annex B7 $\alpha_{g,N}$ see Annex B7, C4, C8, C12, C16
Characteristic resistance to local brick failure and brick edge failure of a screw anchor group under shear loading	$V_{Rk,b,II}^g$, $V_{Rk,b,\perp}^g$, $V_{Rk,c,II}^g$, $V_{Rk,c,\perp}^g$ see Annex B7 $\alpha_{g,VII}$, $\alpha_{g,VII\perp}$ see Annex B7, C4, C8, C12, C16

Essential characteristic	Performance
Edge distances, joint distances, spacing, member thickness	C_{cr} , $S_{cr }$, $S_{cr\perp}$ see Annex B7, C2, C6, C10, C14 C_{min} , $C_{j }$, $C_{j\perp}$, $S_{min }$, $S_{min\perp}$ see Annex C2, C6, C10, C14 h_{min} see Annex C2, C6, C10, C14
Resistance to combined tension and shear loading (hollow and perforated bricks)	No performance assessed
Displacements	δ_{N0} , $\delta_{N\infty}$, δ_{V0} , $\delta_{V\infty}$ see Annex C4, C8, C12, C16

3.2 Safety in case of fire (BWR 2)

Essential characteristic	Performance
Reaction to fire	Class A 1
Resistance to fire	$N_{Rk,s,fi}$, $N_{Rk,p,fi}$, $N_{Rk,b,fi}$, $V_{Rk,s,fi}$, $M^0_{Rk,s,fi}$, $C_{min,fi}$, $C_{j,fi}$ see Annex C1, C5, C9, C13, C17 $N_{Rk,fi}$, $S_{min,fi}$, $C_{min,fi}$, $C_{j,fi}$ see Annex C1, C5, C9, C13, C17

3.3 Aspects of durability

Essential characteristic	Performance
Durability	see Annex B1

4 Assessment and verification of constancy of performance (AVCP) system applied, with reference to its legal base

In accordance with the European Assessment Document EAD 330460-00-0604 the applicable European legal act is: 97/177/EC.

The system to be applied is: 1

5 Technical details necessary for the implementation of the AVCP system, as provided for in the applicable European Assessment Document

Technical details necessary for the implementation of the AVCP system are laid down in the control plan deposited at Deutsches Institut für Bautechnik.

Issued in Berlin on 13 May 2025 by Deutsches Institut für Bautechnik

Dipl.-Ing. Beatrix Wittstock
Head of Section

beglaubigt:
Aksünger

Installed condition without adjustment

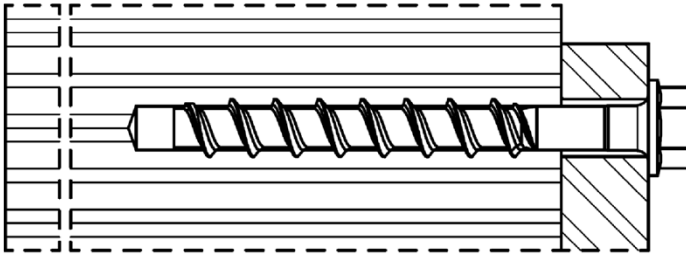

HUS4-H (hexagon head configuration sizes 8 and 10)
HUS4-HF (hexagon head configuration sizes 8 and 10)

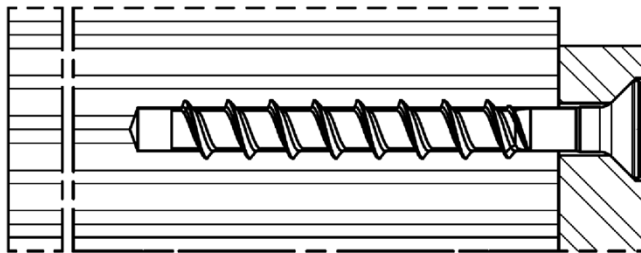

HUS4-C (countersunk head configuration sizes 8 and 10)

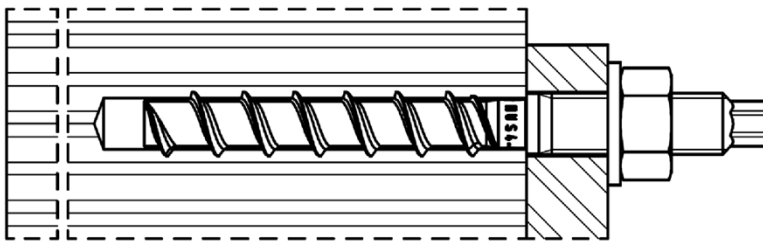

HUS4-A (threaded rod connection size 10)
HUS4-AF (threaded rod connection size 10)

Installed condition with adjustment

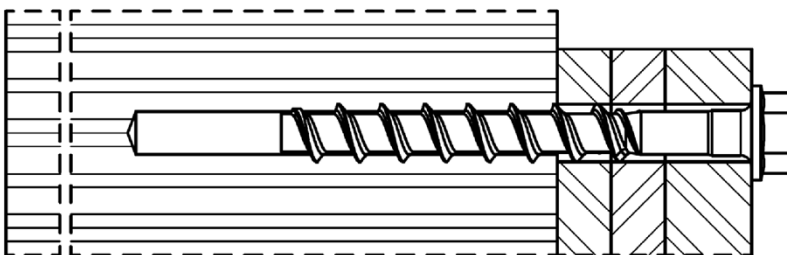

HUS4-H (hexagon head configuration sizes 8 and 10)
HUS4-HF (hexagon head configuration sizes 8 and 10)

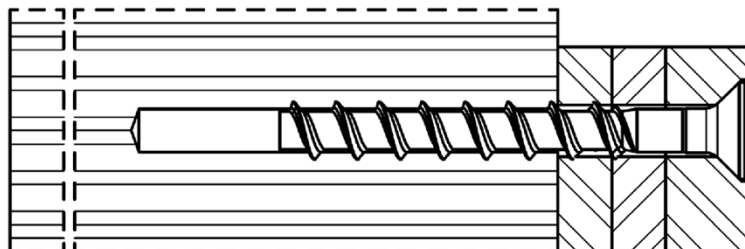

HUS4-C (countersunk head configuration sizes 8 and 10)

Hilti screw anchor HUS4

Product description

Installed condition with and without adjustment

Annex A1

Table A1: Screw types

Hilti HUS4-H, sizes 8 and 10, hexagonal head configuration, carbon steel galvanized
Hilti HUS4-HF, sizes 8 and 10, hexagonal head configuration, carbon steel multilayer coating

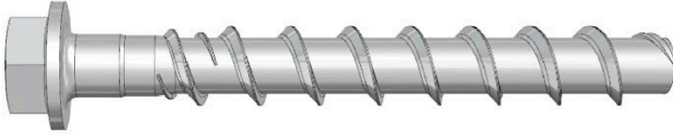

Hilti HUS4-C, sizes 8 and 10, countersunk head configuration, carbon steel galvanized



Hilti HUS4-A, size 10 with external thread M12, carbon steel galvanized
Hilti HUS4-AF, size 10 with external thread M12, carbon steel multilayer coating



Hilti screw anchor HUS4

Product description
HUS4 screw types

Annex A2

Table A2: Hilti filling set (for HUS4-H (F, R) and HUS4-A (F)) and Hilti injection mortar





Filling washer	Spherical washer	Injection mortar
		 Hilti HIT-HY ... with ETA Hilti HIT-RE ... with ETA

Table A3: Materials

Part	Material
HUS4-H(F), HUS4-C and HUS4-A(F) screw anchor	Carbon steel Rupture elongation $A_5 \leq 8\%$
Hilti Filling set (carbon steel)	Filling washer: Carbon steel Spherical washer: Carbon steel

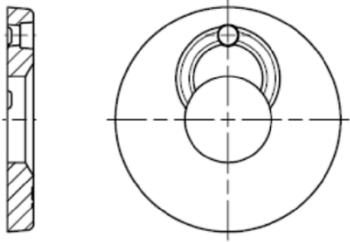
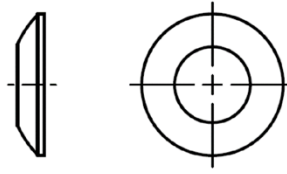
Table A4: Filling set dimensions and compatibility

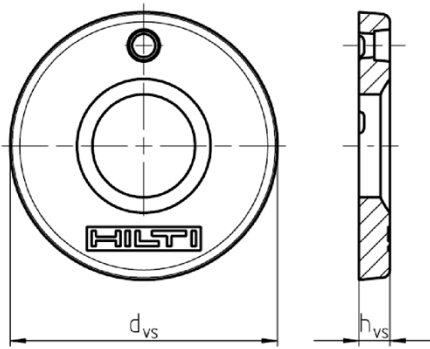
Filling set size	M10	M12	
Diameter of sealing washer d_{vs} [mm]	42	44	
Thickness of sealing washer h_{vs} [mm]	5	5	
Thickness of Hilti Filling Set h_{fs} [mm]	9	10	
HUS4-H (F) 	8	10	
HUS4-A (F) 	-	10	



Hilti screw anchor HUS4

Product description
Filling set and Hilti injection mortar, Materials

Annex A3

Table A5: Fastener dimensions and marking HUS4-A(F)

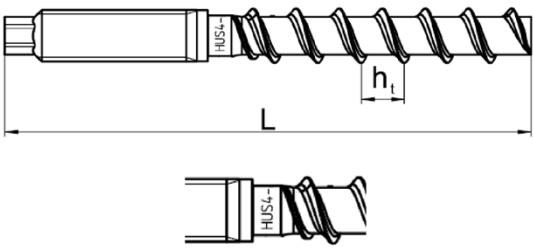
Fastener size HUS4-			A(F) 10
Nominal fastener diameter	d	[mm]	10
Metric thread connection			M12
Pitch of the thread	h_t	[mm]	10
Nominal embedment depth	h_{nom}	[mm]	75
Length of screw min / max	L	[mm]	120 / 165

 <p>E.g. HUS4-A 10x165</p>		HUS4: Hilti Universal Screw 4 th generation		
		A: Thread connection, galvanized		
AF: Thread connection, multilayer coating				
10: Nominal screw diameter d [mm]				
165: Length of screw L [mm]				
8: Carbon steel				
K: Length identification HUS4-A 10x165				
		G	I	K
		10x120	10x140	10x165

Hilti screw anchor HUS4

Production description

Fastener dimensions and head marking

Annex A4

Table A6: Fastener dimensions and marking HUS4-H(F)

Fastener size HUS4-			H(F) 8	H(F) 10
Nominal fastener diameter	d	[mm]	8	10
Pitch of the thread	h_t	[mm]	8	10
Nominal embedment depth	h_{nom}	[mm]	60	75
Length of screw min / max	L	[mm]	65 / 150	80 / 305



		HUS4: Hilti Universal Screw 4 th generation
		H: Hexagonal head, galvanized
		HF: Hexagonal head, multilayer coating
		10: Nominal screw diameter d [mm]
		100: Length of screw [mm]

Table A7: Fastener dimensions and marking HUS4-C

Fastener size HUS4-			C 8	C 10
Nominal fastener diameter	d	[mm]	8	10
Pitch of the thread	h_t	[mm]	8	10
Nominal embedment depth	h_{nom}	[mm]	60	75
Length of screw min / max	L	[mm]	65 / 160	80 / 120

		HUS4: Hilti Universal Screw 4 th generation
		C: Countersunk head, galvanized
		10: Nominal screw diameter d [mm]
		100: Length of screw L [mm]

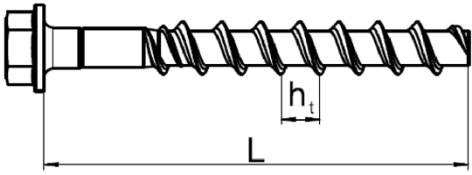
Hilti screw anchor HUS4

Production description
Fastener dimensions and head marking

Annex A5

Specifications of intended use

Anchorage subject to:

- Static and quasi-static loadings
- Fire exposure (for dry masonry only)

Base materials:

- Solid brick masonry, according to Annex B2
- Horizontal joints must completely be filled with mortar. Vertical Joints may, but do not have to be filled with mortar. Mortar strength class of the masonry: M2,5 at minimum according EN 998-2:2016.
- In case of fire all joints have to be filled with mortar according to EN 998-2:2016 with strength class M2.5 at minimum.
- Maximum joint width w_j see annex C3, C7, C11, C15.
- Wall execution and joint dimensions according to EN 1996-1-1:2022.
- Dry or wet masonry (during installation)

Use conditions (Environmental conditions):

- Anchorages subject to dry internal conditions: all screw types
- The covered temperature range of the masonry during the working life is within the range -40 °C to $+80\text{ °C}$

Design:

- Anchorages are designed under the responsibility of an engineer experienced in anchorages and masonry.
- Verifiable calculation notes and drawings are prepared taking account of the loads to be anchored. The position of the fastener is indicated on the design drawings (e. g. position of the fastener relative to reinforcement or to supports, etc.).
- Anchorages are designed in accordance with EOTA Technical Report TR054: Juli 2022
- For solid bricks the characteristic resistances are valid also for bricks with larger dimensions, larger compressive strength or larger bulk density.

Installation:





- Fastener installation carried out by appropriately qualified personnel and under the supervision of the person responsible for technical matters on site.
- In case of aborted hole: new drilling at a minimum distance away of twice the depth of the aborted hole or smaller distance if the aborted hole is filled with high strength mortar and if under shear or oblique tension load it is not the direction of the load application.
- After installation further turning of the fastener must not be possible.
- The head of the fastener (HUS4-H(F) and HUS4-C) must be supported on the fixture and is not damaged.
- Hilti filling set is suitable for HUS4-H(F) and HUS4-A(F).
- The minimum permitted distance from the joints is specified in the annexes C3, C6, C9 and C12.
- Drilling method: hammer drill or rotatory drilling with standard hammer drill bits with cleaned and uncleaned borehole. In case of uncleaned borehole, three times ventilation shall be applied.
- Adjustability according to annex B2.

Hilti screw anchor HUS4

Intended use
Specifications

Annex B1

Table B1: Overview of brick types, properties and fastening elements

Brick type	Picture	Minimum Brick size ¹⁾ [mm]	Trade names ¹⁾ , e.g.	Mean compressive strength $f_{\text{mean}}^{1)}$ [N/mm ²]	HUS4-H(F), C, HF 8	HUS4-A, H(F), C 10	Annex
Solid clay brick EN 771-1		≥ 240x115x52	Mz 1DF Mz NF Mz 2DF Rosso Vivo, Rosso Classico	18 / 27	$h_{\text{nom}} = 60$	$h_{\text{nom}} = 75$	C2
Solid calcium silicate brick EN 771-2		≥ 240x115x113	KS 2DF, KS 8DF	20 / 30	$h_{\text{nom}} = 60$	$h_{\text{nom}} = 75$	C6
Solid lightweight concrete EN 771-3		≥ 498x150x199	LECA murblock	5 / 7,5	$h_{\text{nom}} = 60$	$h_{\text{nom}} = 75$	C10
Aerated concrete EN 771-4		≥ 499x240x249	Xella Ytong Therm-Combi	4 / 6	$h_{\text{nom}} = 60$	$h_{\text{nom}} = 75$	C14

¹⁾ The characteristic resistances are valid also for bricks with larger dimensions, larger compressive strength or larger bulk density

Table B2: Specifications for the adjustment of HUS4 in Masonry

Fastener size HUS4		8	10
Type		H(F), C	H(F), C, A(F)
Nominal embedment depth	h_{nom} [mm]	60	75
Adjustment			
Total max. thickness of adjustment layers	t_{adj} [mm]	10	10
Max. number of adjustments	n_a [-]	2	2

Hilti screw anchor HUS4

Intended use

Overview of brick types and fastening elements

Annex B2

Installation parameters

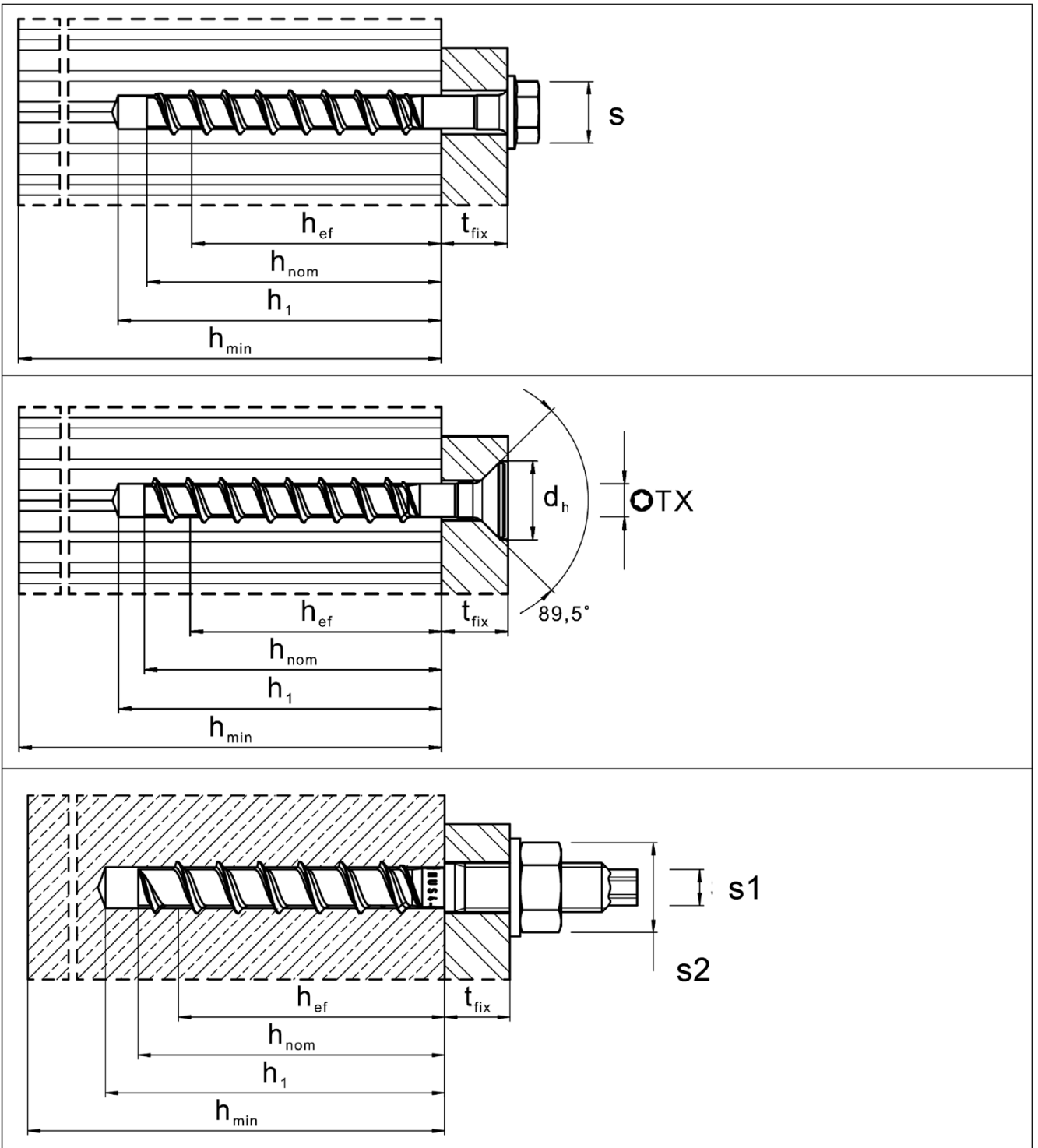

Hilti screw anchor HUS4

Intended use
Installation parameters

Annex B3

Table B3: Installation parameters HUS4 size 8 and 10

Fastener size HUS4			8	10
Type			H(F), C	H(F), C, A(F)
Nominal embedment depth	h_{nom}	[mm]	60	75
Nominal drill hole diameter	d_0	[mm]	8	10
Cutting diameter of drill bit	$d_{cut} \leq$	[mm]	8,45	10,45
Clearance hole diameter through setting	$d_f \frac{\min}{\max}$	[mm]	11	13
			12	14
Clearance hole diameter pre setting (A-type)	$d_f \leq$	[mm]	-	14
Wrench size (H, HF-type)	s	[mm]	13	15
Wrench size for hex head (A-type)	s1	[mm]	-	8
Wrench size for nut (A-type)	s2	[mm]	-	19
Torx size (C-type)	TX	-	45	50
Diameter of countersunk head	d_h	[mm]	18	21
Depth of drill hole for cleaned hole hammer drilling or for uncleaned hole when drilling upwards	$h_1 \geq$	[mm]	(h _{nom} + 10 mm)	
			70	85
Depth of drill hole for uncleaned hole hammer drilling in wall and floor position	$h_1 \geq$	[mm]	(h _{nom} + 10 mm) + 2 * d ₀	
			86	105
Depth of drill hole (with adjustability) for cleaned hole hammer drilling, hammer drilling uncleaned hole when drilling upwards	$h_1 \geq$	[mm]	(h _{nom} + 20 mm)	
			80	95
Depth of drill hole (with adjustability) for uncleaned hole hammer drilling in wall and floor position	$h_1 \geq$	[mm]	(h _{nom} + 20 mm) + 2 * d ₀	
			96	115
Minimum spacing	$s_{min} \geq$	[mm]	80	80

Hilti screw anchor HUS4

Intended use
Installation parameters

Annex B4

Installation instructions

Hole drilling and cleaning

Hammer drilling (HD) all sizes for carbon steel screw types

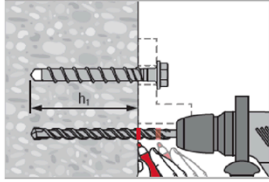

Mark drilling depth h_1 for pre or through installation.
Details for drilling depth h_1 see table B2.

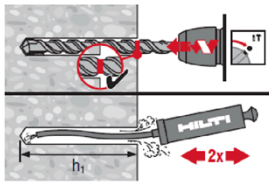

Cleaning needed in downward and horizontal installation direction with drill hole depth $h_1 = h_{nom} + 10 \text{ mm}$

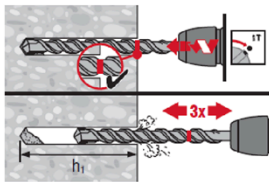

No cleaning is allowed in downward and horizontal installation direction when 3x ventilation¹⁾ after drilling is executed.

Drill hole depth $h_1 = h_{nom} + 10 \text{ mm} + 2 * d_0$

¹⁾ moving the drill bit in and out of the drill hole 3 times after the recommended drilling depth h_1 is achieved. This procedure shall be done with both revolution and hammer functions activated in the drilling machine. For more details read the relevant installation instruction (MPII).

Hilti screw anchor HUS4

Intended use
Installation instructions

Annex B5

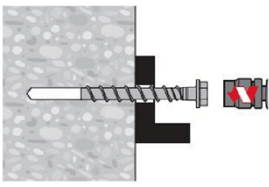
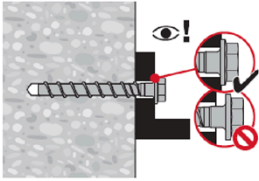
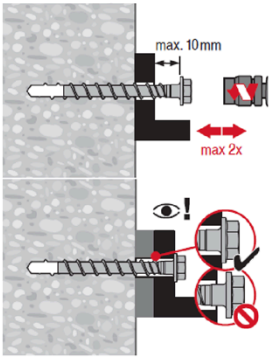
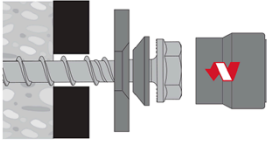
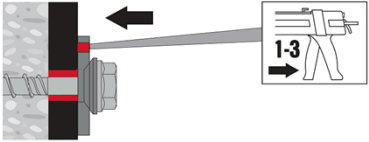
Fastener setting without adjustment	
Setting by screw driver or impact screw driver	
	Installation of the screw with tools and setting parameters listed in Table B2.
Setting check	
	
Fastener setting with adjustment for carbon steel screw types	
Adjusting process	
	A screw can be adjusted maximum two times. The total allowed thickness of shims added during the adjustment process is 10 mm. The final embedment depth after adjustment process must be larger or equal than h_{nom} .
Fastener setting with Hilti filling set	
	
Injection of Hilti HIT mortar and curing time	
	Fill the annular gap between screw and fixture with 1-3 strokes of a Hilti injection mortar HIT-HY ... or HIT-RE Follow the installation instructions supplied with the respective Hilti injection mortar. After required curing time t_{cure} the fastening can be loaded.
Hilti screw anchor HUS4	Annex B6
Intended use Installation instructions	

Definition of installation position and distances

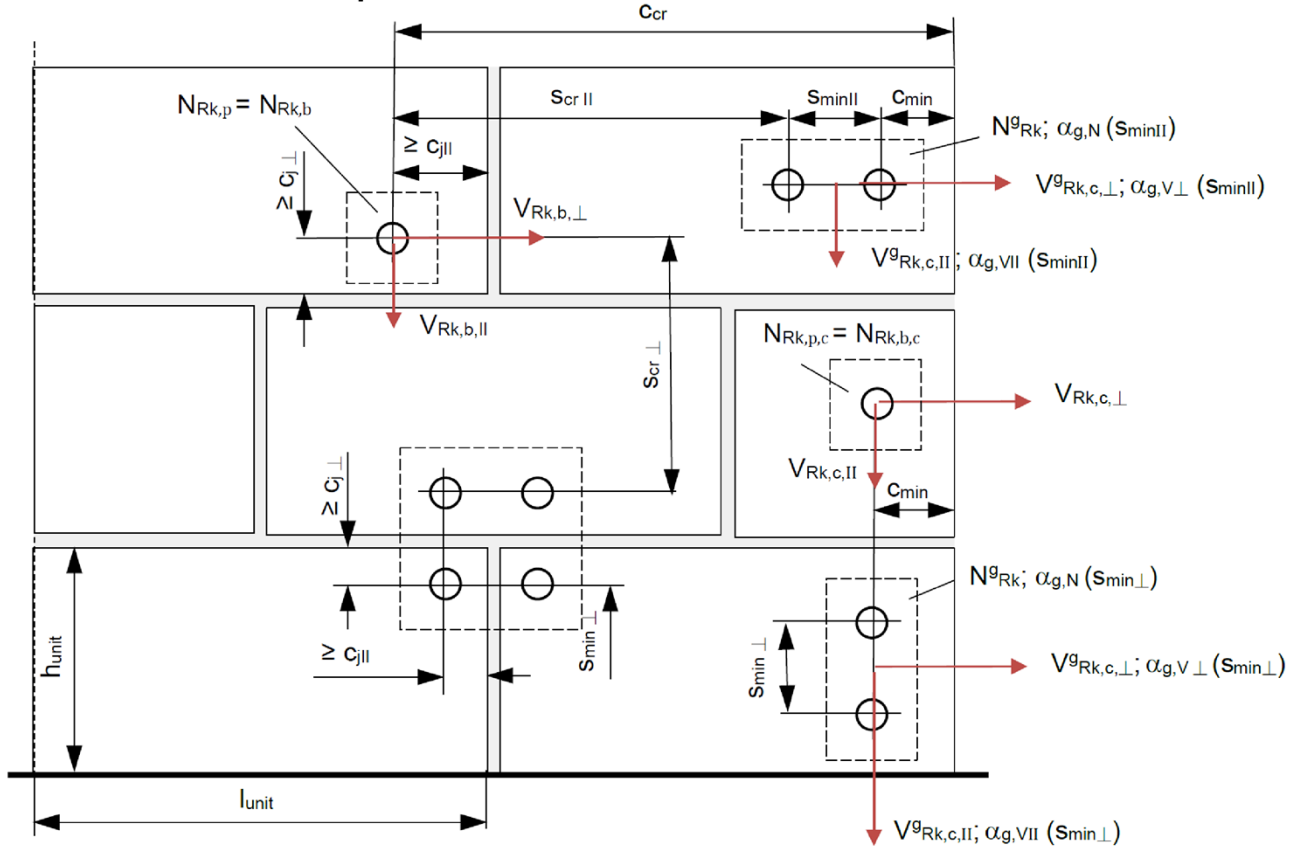

- C_{min} = minimum edge distance to the free edge of the wall
- $C_{j||}$ = distance to vertical joints without influence on resistance of the screw anchor
- $C_{j\perp}$ = distance to horizontal joints without influence on resistance of the screw anchor
- C_{cr} = edge distance for ensuring the transmission of the characteristic resistance of a single screw anchor
- $S_{min||}$ = minimum spacing parallel to the horizontal joint
- $S_{min\perp}$ = minimum spacing perpendicular to the horizontal joint
- $S_{cr||}$ = characteristic spacing parallel to the horizontal joint
- $S_{cr\perp}$ = characteristic spacing perpendicular to the horizontal joint
- l_{unit} = length of the masonry unit
- h_{unit} = height of the masonry unit
- w_j = maximum width of joints
- $\alpha_{g,N}$ = group factor under tension load ($\alpha_{g,N} = \alpha_{g,N}(S_{min||}) = \alpha_{g,N}(S_{min\perp})$)
- $\alpha_{g,V||}$ = group factor under shear load parallel to the edge
- $\alpha_{g,V\perp}$ = group factor under shear load perpendicular to the edge

$N_{Rk} = N_{Rk,b} = N_{Rk,p} = N_{Rk,b,c} = N_{Rk,p,c}$
 $V_{Rk,||} = V_{Rk,b,||} = V_{Rk,c,||}; V_{Rk,\perp} = V_{Rk,b,\perp} = V_{Rk,c,\perp}$
 For $s \geq s_{cr}$: $\alpha_{g,N} = \alpha_{g,V,||} = \alpha_{g,V,\perp} = 2$
 For $s_{min} \leq s \leq s_{cr}$: $\alpha_{g,N}; \alpha_{g,V,||}; \alpha_{g,V,\perp}$ according to group factors of brick in Annex C
 $N^g_{Rk} = \alpha_{g,N} \cdot N_{Rk}$ (group of 2 anchors)
 $V^g_{Rk,||(s_{min||})} = \alpha_{g,V,||(s_{min||})} \cdot V_{Rk,||}; V^g_{Rk,||(s_{min\perp})} = \alpha_{g,V,||(s_{min\perp})} \cdot V_{Rk,||}$ (group of 2 anchors)
 $V^g_{Rk,\perp(s_{min||})} = \alpha_{g,V,\perp(s_{min||})} \cdot V_{Rk,\perp}; V^g_{Rk,\perp(s_{min\perp})} = \alpha_{g,V,\perp(s_{min\perp})} \cdot V_{Rk,\perp}$ (group of 2 anchors)
 $N^g_{Rk} = \alpha_{g,N}^2 \cdot N_{Rk}$ (group of 4 anchors)
 $V^g_{Rk,||} = \alpha_{g,V,||(s_{min||})} \cdot \alpha_{g,V,||(s_{min\perp})} \cdot V_{Rk,||}; V^g_{Rk,\perp} = \alpha_{g,V,\perp(s_{min||})} \cdot \alpha_{g,V,\perp(s_{min\perp})} \cdot V_{Rk,\perp}$ (group of 4 anchors)

Hilti screw anchor HUS4

Intended use
Definition of installation position and distances

Annex B7

Table C1: Characteristic resistance to steel failure of a single screw anchor under tension and shear loading

Fastener size HUS4			8	10
Type			H(F), C	H(F), C, A(F)
Steel failure for tension load				
Characteristic resistance	$N_{Rk,s}$	[kN]	36,0	55,0
Partial factor	$\gamma_{Ms,N}^{1)}$	[-]	1,5	1,5
Steel failure for shear load				
Characteristic resistance	$V_{Rk,s}$	[kN]	18,8	28,8
Partial factor	$\gamma_{Ms,V}^{1)}$	[-]	1,25	
Characteristic resistance	$M^0_{Rk,s}$	[Nm]	32	64

¹⁾ In absence of other national regulations

Table C2: Resistance to fire

Fastener size HUS4			8	10	
Type			H(F), C	H(F), C, A(F)	
Nominal embedment depth	h_{nom}	[mm]	60	75	
Steel failure for tension and shear load under fire exposure					
Characteristic resistance	R30	$N_{Rk,s,fi} = V_{Rk,s,fi}$	[kN]	0,47	1,03
	R60	$N_{Rk,s,fi} = V_{Rk,s,fi}$	[kN]	0,42	0,89
	R90	$N_{Rk,s,fi} = V_{Rk,s,fi}$	[kN]	0,33	0,68
	R120	$N_{Rk,s,fi} = V_{Rk,s,fi}$	[kN]	0,23	0,55
	R30	$M^0_{Rk,s,fi}$	[Nm]	0,42	1,20
	R60	$M^0_{Rk,s,fi}$	[Nm]	0,37	1,04
	R90	$M^0_{Rk,s,fi}$	[Nm]	0,29	0,80
	R120	$M^0_{Rk,s,fi}$	[Nm]	0,21	0,64

Hilti screw anchor HUS4

Performances
Essential characteristics under static and quasi-static load and fire exposure

Annex C1

Brick type: Solid clay brick

Table C3: Description of brick

Brick type		[-]	Solid	
Bulk density	ρ	[kg/dm ³]	1,5	
Mean compressive strength	f_{mean}	[N/mm ²]	≥ 18	
Code		[-]	EN 771-1:2011	
Brick dimensions	l x b x h	[mm]	≥ 240 x 115 x 52	
Minimum wall thickness	h_{min}	[mm]	≥ 115	

Table C4: Installation parameters

Fastener size HUS4			8	10
Type			H(F), C	H(F), C, A(F)
Setting parameters				
Nominal embedment depth	h_{nom}	[mm]	60	75
Setting tool: screwdriver and power limitation		[-]	Must not be used	
Setting tool: impact screw wrench ¹⁾	Type and power limitation	[-]	SIW 4AT-22 Gear 1	SIW 4AT-22 Gear 1
	Maximum torque according manufacturer specification	[Nm]	90	90
Edge distance and spacing				
Minimum edge distance from free edge	c_{min}	[mm]	1,5 h_{nom}	
Minimum spacing	$s_{\text{min}} \parallel = s_{\text{min}} \perp$	[mm]	80	
Characteristic distance from free edge	c_{cr}	[mm]	1,5 h_{nom}	
Characteristic spacing	s_{cr}	[mm]	3,0 h_{nom}	

¹⁾ Installation with other impact screwdriver of equivalent or lower power output is possible.

Hilti screw anchor HUS4

Performances

Essential characteristics under static and quasi-static load in solid clay bricks

Annex C2

Table C5: Characteristic resistance under tension and shear load

Fastener size HUS4 Type	8 H(F), C		10 H(F), C, A(F)	
	dry	wet	dry	wet
Use category				
Nominal embedment depth h_{nom} [mm]	60		75	
Characteristic resistance to pull-out failure or brick breakout failure of a single screw anchor under tension loading				
Mean compressive brick strength f_{mean} [MPa]	$N_{Rk} = N_{Rk,b} = N_{Rk,p} = N_{Rk,b,c} = N_{Rk,p,c}$ [kN]			
≥ 18	5,5		7,0	
≥ 27	6,7		8,5	
Characteristic resistance to local brick breakout failure of a screw anchor under shear loading				
Mean compressive brick strength f_{mean} [MPa]	$V_{Rk,\parallel} = V_{Rk,b,\parallel} = V_{Rk,c,\parallel}$ [kN]			
≥ 18	7,9		11,4	
≥ 27	9,7		14,0	
Mean compressive brick strength f_{mean} [MPa]	$V_{Rk,\perp} = V_{Rk,b,\perp} = V_{Rk,c,\perp}$ [kN]			
≥ 18	4,4		4,4	
≥ 27	5,3		5,3	

Table C6: Reduction factors depending on the distance from the joints

Fastener size HUS4 Type	8 H(F), C		10 H(F), C, A(F)	
	Nominal embedment depth h_{nom} [mm]	60		75
Maximum joint width w_j [mm]	≤ 10		≤ 10	
Distance from the joints $c_{j,\perp}$ [mm]	≥ 26		≥ 26	
	$c_{j,\parallel}$ $\geq 1,5 h_{nom}$		$\geq 1,5 h_{nom}$	
Joint factor $\alpha_{j,N}$ [-]	1,0		1,0	
	$\alpha_{j,V\parallel}$ 1,0		1,0	
	$\alpha_{j,V\perp}$ 1,0		1,0	
Distance from the joints $c_{j,\perp}$ [mm]	≥ 20		≥ 20	
	$c_{j,\parallel}$ ≥ 20		≥ 20	
Joint factor $\alpha_{j,N}$ [-]	0,88		0,83	
	$\alpha_{j,V\parallel}$ 1,0		1,0	
	$\alpha_{j,V\perp}$ 1,0		1,0	
Distance from the joints $c_{j,\perp}$ [mm]	< 20		< 20	
	$c_{j,\parallel}$ < 20		< 20	
Joint factor $\alpha_{j,N}$ [-]	Screw must not be used			
$\alpha_{j,V\parallel} = \alpha_{j,V\perp}$				

Hilti screw anchor HUS4

Performances
Essential characteristics under static and quasi-static load in solid clay bricks

Annex C3

Table C7: Group factors for double groups



Fastener size HUS4			Use case	8	10
Type				H(F), C	H(F), C, A(F)
Minimum spacing	$s_{min\parallel} = s_{min\perp}$	[mm]	-	80	80
Group factor for tension	$\alpha_{g,N}(s_{min\parallel}) = \alpha_{g,N}(s_{min\perp})$	[-]		1,70	1,25
Group factor for shear with minimum spacing in direction parallel to the horizontal joint	$\alpha_{g,V\perp}(s_{min\parallel}) = \alpha_{g,V\parallel}(s_{min\parallel})$	[-]		2,00	2,00
Group factor for shear with minimum spacing in direction perpendicular to the horizontal joint	$\alpha_{g,V\perp}(s_{min\perp}) = \alpha_{g,V\parallel}(s_{min\perp})$	[-]		1,70	1,70

Table C8: Displacements

Fastener size HUS4			8	10
Type			H(F), C	H(F), C, A(F)
Nominal embedment depth	h_{nom}	[mm]	60	75
Tension load	F_N	[kN]	1,9	2,4
Displacements under tension load	δ_{N0}	[mm]	1,3	0,9
	$\delta_{N\infty}$		2,6	1,8
Shear load parallel to the vertical joint	$F_{V\parallel}$	[kN]	2,8	4,0
Displacements under shear load ¹⁾	$\delta_{V\parallel 0}$	[mm]	1,7	2,3
	$\delta_{V\parallel \infty}$		2,6	3,5
Shear load perpendicular to the vertical joint	$F_{V\perp}$	[kN]	1,5	1,5
Displacements under shear load ¹⁾	$\delta_{V\perp 0}$	[mm]	1,2	1,2
	$\delta_{V\perp \infty}$		1,8	1,8

¹⁾ Shear displacements do not consider the fixture hole clearance and the respective screw position. Clearance hole displacements can be avoided with the use of the Hilti filling set.

Hilti screw anchor HUS4

Performances

Essential characteristics under static and quasi-static load in solid clay bricks

Annex C4

Table C9: Resistance to fire

Fastener size HUS4				8	10
Type				H(F), C	H(F), C, A(F)
Nominal embedment depth		h_{nom}	[mm]	60	75
Characteristic resistance to pullout and brick breakout failure $N_{Rk,fi} = N_{Rk,p,fi} = N_{Rk,b,fi}$ of a single anchor					
Mean compressive brick strength $f_{mean} \geq 18$ MPa	R30, R60, R90	$N_{Rk,fi}$	[kN]	0,9	1,2
	R120	$N_{Rk,fi}$	[kN]	0,7	0,9
Mean compressive brick strength $f_{mean} \geq 27$ MPa	R30, R60, R90	$N_{Rk,fi}$	[kN]	1,1	1,4
	R120	$N_{Rk,fi}$	[kN]	0,9	1,1
Characteristic resistance to brick breakout failure $N_{Rk,b,fi}^g$ for double screw anchor groups					
Mean compressive brick strength $f_{mean} \geq 18$ MPa	R30, R60, R90	$N_{Rk,b,fi}^g$	[kN]	2,0	2,3
	R120	$N_{Rk,b,fi}^g$	[kN]	1,6	1,8
Mean compressive brick strength $f_{mean} \geq 27$ MPa	R30, R60, R90	$N_{Rk,b,fi}^g$	[kN]	2,4	2,7
	R120	$N_{Rk,b,fi}^g$	[kN]	1,9	2,2
Edge distance and spacing					
Minimum edge distance		$c_{min,fi} = c_{j,fi}$	[mm]	120	150
Minimum spacing		$s_{min,fi}$	[mm]	106	106

Hilti screw anchor HUS4

Performances

Essential characteristics under fire exposure in solid clay bricks

Annex C5

Brick type: Solid calcium silicate brick

Table C10: Description of brick

Brick type		[-]	Solid	
Bulk density	ρ	[kg/dm ³]	$\geq 1,7$	
Mean compressive strength	f_{mean}	[N/mm ²]	≥ 20	
Code		[-]	EN 771-2:2011	
Brick dimensions	$l \times b \times h$	[mm]	$\geq 240 \times 115 \times 113$	
Minimum wall thickness	h_{min}	[mm]	≥ 115	

Table C11: Installation parameters

Fastener size HUS4			8	10
Type			H(F), C	H(F), C, A(F)
Setting parameters				
Nominal embedment depth	h_{nom}	[mm]	60	75
Setting tool: screwdriver and power limitation		[-]	Must not be used	
Setting tool: impact screw wrench ¹⁾	Type and power limitation	[-]	SIW 4AT-22 Gear 1	SIW 4AT-22 Gear 1
	Maximum torque according manufacturer specification	[Nm]	90	90
Edge distance and spacing				
Minimum edge distance from free edge	c_{min}	[mm]	$1,5 h_{\text{nom}}$	
Minimum spacing	$s_{\text{min}} \parallel = s_{\text{min}}^{\perp}$	[mm]	80	
Characteristic distance from free edge	c_{cr}	[mm]	$1,5 h_{\text{nom}}$	
Characteristic spacing	s_{cr}	[mm]	$3,0 h_{\text{nom}}$	

¹⁾ Installation with other impact screwdriver of equivalent or lower power output is possible.

Hilti screw anchor HUS4

Performances

Essential characteristics under static and quasi-static load in solid calcium silicate bricks

Annex C6

Table C12: Characteristic resistance under tension and shear load

Fastener size HUS4 Type	8 H(F), C		10 H(F), C, A(F)	
	dry	wet	dry	wet
Use category				
Nominal embedment depth h_{nom} [mm]	60		75	
Characteristic resistance to pull-out failure or brick breakout failure of a single screw anchor under tension loading				
Mean compressive brick strength f_{mean} [MPa]	$N_{Rk} = N_{Rk,b} = N_{Rk,p} = N_{Rk,b,c} = N_{Rk,p,c}$ [kN]			
≥ 20	9,4		9,9	9,4
≥ 30	11,3		12,0	11,3
Characteristic resistance to local brick breakout failure of a screw anchor under shear loading				
Mean compressive brick strength f_{mean} [MPa]	$V_{Rk,\parallel} = V_{Rk,b,\parallel} = V_{Rk,c,\parallel}$ [kN]			
≥ 20	13,6		15,6	
≥ 30	16,4		18,8	
Mean compressive brick strength f_{mean} [MPa]	$V_{Rk,\perp} = V_{Rk,b,\perp} = V_{Rk,c,\perp}$ [kN]			
≥ 20	3,5		3,5	
≥ 30	4,3		4,3	

Table C13: Reduction factors depending on the distance from the joints

Fastener size HUS4 Type	8 H(F), C		10 H(F), C, A(F)	
	Nominal embedment depth h_{nom} [mm]	60		75
Maximum joint width w_j [mm]	≤ 10		≤ 10	
Distance from the joints $c_{j\perp}$ [mm]	$\geq 41,5$		$\geq 41,5$	
	$c_{j\parallel}$ $\geq 1,5 h_{mon}$		$\geq 1,5 h_{mon}$	
Joint factor $\alpha_{j,N}$ [-]	1,0		1,0	
	$\alpha_{j,V\parallel}$ 1,0		1,0	
	$\alpha_{j,V\perp}$ 1,0		1,0	
Distance from the joints $c_{j\perp}$ [mm]	≥ 20		≥ 20	
	$c_{j\parallel}$ ≥ 40		≥ 40	
Joint factor $\alpha_{j,N}$ [-]	0,78		0,87	
	$\alpha_{j,V\parallel}$ 1,0		1,0	
	$\alpha_{j,V\perp}$ 1,0		1,0	
Distance from the joints $c_{j\perp}$ [mm]	< 20		< 20	
	$c_{j\parallel}$ < 40		< 40	
Joint factor $\alpha_{j,N}$ [-]	Screw must not be used			
$\alpha_{j,V\parallel}$				
$\alpha_{j,V\perp}$				

Hilti screw anchor HUS4

Performances

Essential characteristics under static and quasi-static load in solid calcium silicate bricks

Annex C7

Table C14: Group factors for double groups

Fastener size HUS4			Use case	8	10
Type				H(F), C	H(F), C, A(F)
Minimum spacing	$s_{min\parallel} = s_{min\perp}$	[mm]	-	80	80
Group factor for tension	$\alpha_{g,N}(s_{min\parallel}) = \alpha_{g,N}(s_{min\perp})$	[-]		1,45	1,80
Group factor for shear with minimum spacing in direction parallel to the horizontal joint	$\alpha_{g,V\perp}(s_{min\parallel}) = \alpha_{g,V\parallel}(s_{min\parallel})$	[-]		1,70	1,70
Group factor for shear with minimum spacing in direction perpendicular to the horizontal joint	$\alpha_{g,V\perp}(s_{min\perp}) = \alpha_{g,V\parallel}(s_{min\perp})$	[-]		1,45	1,45

Table C15: Displacements

Fastener size HUS4			8	10
Type			H(F), C	H(F), C, A(F)
Nominal embedment depth	h_{nom}	[mm]	60	75
Tension load	F_N	[kN]	3,2	3,4
Displacements under tension load	δ_{N0}	[mm]	0,4	0,4
	$\delta_{N\infty}$		0,8	0,8
Shear load parallel to the vertical joint	$F_{V\parallel}$	[kN]	4,7	5,4
Displacements under shear load ¹⁾	$\delta_{V\parallel 0}$	[mm]	1,7	1,7
	$\delta_{V\parallel \infty}$		2,6	2,6
Shear load perpendicular to the vertical joint	$F_{V\perp}$	[kN]	1,2	1,2
Displacements under shear load ¹⁾	$\delta_{V\perp 0}$	[mm]	0,7	0,7
	$\delta_{V\perp \infty}$		1,1	1,1

¹⁾ Shear displacements do not consider the fixture hole clearance and the respective screw position. Clearance hole displacements can be avoided with the use of the Hilti filling set.

Hilti screw anchor HUS4

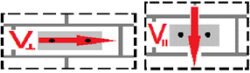
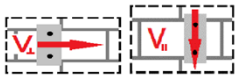
Performances

Essential characteristics under static and quasi-static load in solid calcium silicate bricks

Annex C8

Table C16: Resistance to fire

Fastener size HUS4				8	10
Type				H(F), C	H(F), C, A(F)
Nominal embedment depth	h_{nom}	[mm]		60	75
Characteristic resistance to pullout and brick failure $N_{Rk,fi} = N_{Rk,p,fi} = N_{Rk,b,fi}$					
Mean compressive brick strength $f_{mean} \geq 20$ MPa	R30, R60, R90	$N_{Rk,fi}$	[kN]	1,6	1,7
	R120	$N_{Rk,fi}$	[kN]	1,3	1,3
Mean compressive brick strength $f_{mean} \geq 30$ MPa	R30, R60, R90	$N_{Rk,fi}$	[kN]	1,9	2,1
	R120	$N_{Rk,fi}$	[kN]	1,5	1,6
Characteristic resistance to brick breakout failure $N^g_{Rk,b,fi}$ for double screw anchor groups					
Mean compressive brick strength $f_{mean} \geq 20$ MPa	R30, R60, R90	$N^g_{Rk,b,fi}$	[kN]	2,8	4,6
	R120	$N^g_{Rk,b,fi}$	[kN]	2,2	3,7
Mean compressive brick strength $f_{mean} \geq 30$ MPa	R30, R60, R90	$N^g_{Rk,b,fi}$	[kN]	3,4	5,6
	R120	$N^g_{Rk,b,fi}$	[kN]	2,7	4,5
Edge distance and spacing					
Minimum edge distance	$c_{min,fi} = c_{j,fi}$	[mm]		120	150
Minimum spacing	$s_{min,fi}$	[mm]		106	106

Hilti screw anchor HUS4

Performances

Essential characteristics under fire exposure load in solid calcium silicate bricks

Annex C9

Brick type: Lightweight concrete brick

Table C17: Description of brick

Brick type		[-]	Solid	
Bulk density	ρ	[kg/dm ³]	≥ 0,9	
Mean compressive strength	f_{mean}	[N/mm ²]	≥ 5	
Code		[-]	EN 771-3:2011	
Brick dimensions	$l \times b \times h$	[mm]	≥ 498 x 150 x 199	
Minimum wall thickness	h_{min}	[mm]	≥ 150	

Table C18: Installation parameters

Fastener size HUS4			8	10
Type			H(F), C	H(F), C, A(F)
Setting parameters				
Nominal embedment depth	h_{nom}	[mm]	60	75
Setting tool: screwdriver and power limitation		[-]	SF 6H-A22 Gear 2 / 10	SF 6H-A22 Gear 2 / 15
Setting tool: impact screw wrench	Type and power limitation Maximum torque according manufacturer specification	[-] [Nm]	Must not be used	
Edge distance and spacing				
Minimum edge distance from free edge	c_{min}	[mm]	1,5 h_{nom}	
Minimum spacing	$s_{\text{min}} \parallel = s_{\text{min}} \perp$	[mm]	80	
Characteristic distance from free edge	c_{cr}	[mm]	1,5 h_{nom}	
Characteristic spacing	s_{cr}	[mm]	3,0 h_{nom}	

Hilti screw anchor HUS4

Performances

Essential characteristics under static and quasi-static load in solid lightweight concrete bricks

Annex C10

Table C19: Characteristic resistance under tension and shear load

Fastener size HUS4 Type	8 H(F), C		10 H(F), C, A(F)	
	dry	wet	dry	wet
Use category				
Nominal embedment depth h_{nom} [mm]	60		75	
Characteristic resistance to pull-out failure or brick breakout failure of a single screw anchor under tension loading				
Mean compressive brick strength f_{mean} [MPa]	$N_{Rk} = N_{Rk,b} = N_{Rk,p} = N_{Rk,b,c} = N_{Rk,p,c}$ [kN]			
$\geq 5,0$	2,8		3,5	
$\geq 7,5$	3,5		4,5	
Characteristic resistance to local brick breakout failure of a screw anchor under shear loading				
Mean compressive brick strength f_{mean} [MPa]	$V_{Rk,\parallel} = V_{Rk,b,\parallel} = V_{Rk,c,\parallel}$ [kN]			
$\geq 5,0$	1,8		4,2	
$\geq 7,5$	2,1		5,2	
Mean compressive brick strength f_{mean} [MPa]	$V_{Rk,\perp} = V_{Rk,b,\perp} = V_{Rk,c,\perp}$ [kN]			
$\geq 5,0$	1,3		1,6	
$\geq 7,5$	1,6		1,9	

Table C20: Reduction factors depending on the distance from the joints

Fastener size HUS4 Type	8 H(F), C		10 H(F), C, A(F)	
	Nominal embedment depth h_{nom} [mm]	60		75
Maximum joint width w_j [mm]	≤ 10		≤ 10	
Distance from the joints $c_{j\perp}$ [mm]	$\geq 1,5 h_{nom}$		≥ 99	
	$c_{j\parallel}$		$\geq 1,5 h_{nom}$	
Joint factor $\alpha_{j,N}$ [-]	1,0		1,0	
	$\alpha_{j,V\parallel}$		1,0	
	$\alpha_{j,V\perp}$		1,0	
Distance from the joints $c_{j\perp}$ [mm]	≥ 20		≥ 20	
	$c_{j\parallel}$		≥ 40	
Joint factor $\alpha_{j,N}$ [-]	0,76		0,59	
	$\alpha_{j,V\parallel}$		1,00	
	$\alpha_{j,V\perp}$		0,60	
Distance from the joints $c_{j\perp}$ [mm]	< 20		< 20	
	$c_{j\parallel}$		< 40	
Joint factor $\alpha_{j,N}$ [-]	Screw must not be used			
$\alpha_{j,V\parallel}$				
$\alpha_{j,V\perp}$				

Hilti screw anchor HUS4

Annex C11

Performances

Essential characteristics under static and quasi-static load in solid lightweight concrete bricks

Table C21: Group factors for double groups



Fastener size HUS4			Use case	8	10
Type				H(F), C	H(F), C, A(F)
Minimum spacing	$s_{min\parallel} = s_{min\perp}$	[mm]	-	80	80
Group factor for tension	$\alpha_{g,N}(s_{min\parallel}) = \alpha_{g,N}(s_{min\perp})$	[-]		2,00	1,60
Group factor for shear with minimum spacing in direction parallel to the horizontal joint	$\alpha_{g,V\perp}(s_{min\parallel}) = \alpha_{g,V\parallel}(s_{min\parallel})$	[-]		1,60	1,60
Group factor for shear with minimum spacing in direction perpendicular to the horizontal joint	$\alpha_{g,V\perp}(s_{min\perp}) = \alpha_{g,V\parallel}(s_{min\perp})$	[-]		2,00	2,00

Table C22: Displacements

Fastener size HUS4			8	10
Type			H(F), C	H(F), C, A(F)
Nominal embedment depth	h_{nom}	[mm]	60	75
Tension load	F_N	[kN]	0,8	1,0
Displacements under tension load	δ_{N0}	[mm]	0,05	0,10
	$\delta_{N\infty}$		0,10	0,20
Shear load parallel to the vertical joint	$F_{V\parallel}$	[kN]	0,6	1,5
Displacements under shear load ¹⁾	$\delta_{V\parallel 0}$	[mm]	0,50	0,70
	$\delta_{V\parallel \infty}$		0,75	1,10
Shear load perpendicular to the vertical joint	$F_{V\perp}$	[kN]	0,5	0,5
Displacements under shear load ¹⁾	$\delta_{V\perp 0}$	[mm]	0,70	0,60
	$\delta_{V\perp \infty}$		1,10	0,90

¹⁾ Shear displacements do not consider the fixture hole clearance and the respective screw position. Clearance hole displacements can be avoided with the use of the Hilti filling set.

Hilti screw anchor HUS4

Performances

Essential characteristics under static and quasi-static load in solid lightweight concrete bricks

Annex C12

Table C23: Resistance to fire

Fastener size HUS4				8	10
Type				H(F), C	H(F), C, A(F)
Nominal embedment depth		h_{nom}	[mm]	60	75
Characteristic resistance to pullout and brick failure $N_{Rk,fi} = N_{Rk,p,fi} = N_{Rk,b,fi}$					
Mean compressive brick strength $f_{mean} \geq 5$ MPa	R30, R60, R90	$N_{Rk,fi}$	[kN]	0,4	0,4
	R120	$N_{Rk,fi}$	[kN]	0,3	0,3
Mean compressive brick strength $f_{mean} \geq 7,5$ MPa	R30, R60, R90	$N_{Rk,fi}$	[kN]	0,4	0,6
	R120	$N_{Rk,fi}$	[kN]	0,3	0,4
Characteristic resistance to brick breakout failure $N^g_{Rk,b,fi}$ for double screw anchor groups					
Mean compressive brick strength $f_{mean} \geq 5$ MPa	R30, R60, R90	$N^g_{Rk,b,fi}$	[kN]	0,9	1,1
	R120	$N^g_{Rk,b,fi}$	[kN]	0,7	0,9
Mean compressive brick strength $f_{mean} \geq 7,5$ MPa	R30, R60, R90	$N^g_{Rk,b,fi}$	[kN]	1,1	1,4
	R120	$N^g_{Rk,b,fi}$	[kN]	0,9	1,1
Edge distance and spacing					
Minimum edge distance		$c_{min,fi} = c_{j,fi}$	[mm]	120	150
Minimum spacing		$s_{min,fi}$	[mm]	106	106

Hilti screw anchor HUS4

Performances

Essential characteristics under fire exposure in solid lightweight concrete bricks

Annex C13

Brick type: Autoclaved aerated concrete

Table C24: Description of brick

Brick type		[-]	Solid	
Bulk density	ρ	[kg/dm ³]	≥ 0,55	
Mean compressive strength	f_{mean}	[N/mm ²]	≥ 4	
Code		[-]	EN 771-4:2011	
Brick dimensions	l x b x h	[mm]	≥ 499 x 240 x 249	
Minimum wall thickness	h_{min}	[mm]	≥ 240	

Table C25: Installation parameters

Fastener size HUS4		8	10	
Type		H(F), C	H(F), C, A(F)	
Setting parameters				
Nominal embedment depth	h_{nom}	[mm]	60	75
Setting tool: screwdriver and power limitation		[-]	SF 6H-A22 Gear 2 / 10	SF 6H-A22 Gear 2 / 15
Setting tool: impact screw wrench	Type and power limitation	[-]	Must not be used	
	Maximum torque according manufacturer specification	[Nm]		
Edge distance and spacing				
Minimum edge distance from free edge	c_{min}	[mm]	1,5 h_{nom}	
Minimum spacing	$s_{\text{min}} \parallel = s_{\text{min}} \perp$	[mm]	80	
Characteristic distance from free edge	c_{cr}	[mm]	1,5 h_{nom}	
Characteristic spacing	s_{cr}	[mm]	3,0 h_{nom}	

Hilti screw anchor HUS4

Performances

Essential characteristics under static and quasi-static load in autoclaved aerated concrete bricks

Annex C14

Table C26: Characteristic resistance under tension and shear load

Fastener size HUS4 Type	8 H(F), C		10 H(F), C, A(F)	
	dry	wet	dry	wet
Use category				
Nominal embedment depth h_{nom} [mm]	60		75	
Characteristic resistance to pull-out failure or brick breakout failure of a single screw anchor under tension loading				
Mean compressive brick strength f_{mean} [MPa] / bulk density [kg/m ³]	$N_{Rk} = N_{Rk,b} = N_{Rk,p} = N_{Rk,b,c} = N_{Rk,p,c}$ [kN]			
≥ 4 / 550	0,5		0,8	
≥ 6 / 650	0,9		1,4	
Characteristic resistance to local brick breakout failure of a screw anchor under shear loading				
Mean compressive brick strength f_{mean} [MPa] / bulk density [kg/m ³]	$V_{Rk, } = V_{Rk,b, } = V_{Rk,c, }$ [kN]			
≥ 4 / 550	1		1,6	
≥ 6 / 650	1,8		2,8	
Mean compressive brick strength f_{mean} [MPa] / bulk density [kg/m ³]	$V_{Rk,\perp} = V_{Rk,b,\perp} = V_{Rk,c,\perp}$ [kN]			
≥ 4 / 550	0,3		0,4	
≥ 6 / 650	0,5		0,7	

Table C27: Reduction factors depending on the distance from the joints

Fastener size HUS4 Type	8 H(F), C		10 H(F), C, A(F)	
	Nominal embedment depth h_{nom} [mm]	60		75
Maximum joint width w_j [mm]	≤ 3		≤ 3	
Distance from the joints c_j [mm]	c_j^\perp	≥ 1,5 h_{nom}		≥ 1,5 h_{nom}
	c_j^\parallel	≥ 1,5 h_{nom}		≥ 1,5 h_{nom}
Joint factor $\alpha_{j,N}$ [-]	$\alpha_{j,N}$	1,0		1,0
	α_{j,V^\parallel}	1,0		1,0
	α_{j,V^\perp}	1,0		1,0
Distance from the joints c_j [mm]	c_j^\perp	≥ 20		≥ 20
	c_j^\parallel	≥ 40		≥ 40
Joint factor $\alpha_{j,N}$ [-]	$\alpha_{j,N}$	0,73		0,96
	α_{j,V^\parallel}	1,0		1,0
	α_{j,V^\perp}	0,55		0,45
Distance from the joints c_j [mm]	c_j^\perp	< 20		< 20
	c_j^\parallel	< 40		< 40
Joint factor $\alpha_{j,N}$ [-]	Screw must not be used			

Hilti screw anchor HUS4

Annex C15

Performances

Essential characteristics under static and quasi-static load in autoclaved aerated concrete bricks

Table C28: Group factors for double groups

Fastener size HUS4			Use case	8	10
Type				H(F), C	H(F), C, A(F)
Minimum spacing	$s_{min\parallel} = s_{min\perp}$	[mm]	-	80	80
Group factor for tension	$\alpha_{g,N}(s_{min\parallel}) = \alpha_{g,N}(s_{min\perp})$	[-]		1,85	2,00
Group factor for shear with minimum spacing in direction parallel to the horizontal joint	$\alpha_{g,V\perp}(s_{min\parallel}) = \alpha_{g,V\parallel}(s_{min\parallel})$	[-]		2,00	2,00
Group factor for shear with minimum spacing in direction perpendicular to the horizontal joint	$\alpha_{g,V\perp}(s_{min\perp}) = \alpha_{g,V\parallel}(s_{min\perp})$	[-]		1,25	1,00

Table C29: Displacements

Fastener size HUS4			8	10
Type			H(F), C	H(F), C, A(F)
Nominal embedment depth	h_{nom}	[mm]	60	75
Tension load	F_N	[kN]	0,3	0,5
Displacements under tension load	δ_{N0}	[mm]	0,02	0,03
	$\delta_{N\infty}$		0,04	0,06
Shear load parallel to the vertical joint	$F_{V\parallel}$	[kN]	0,6	1,0
Displacements under shear load ¹⁾	$\delta_{V\parallel 0}$	[mm]	1,20	1,20
	$\delta_{V\parallel \infty}$		1,80	1,80
Shear load perpendicular to the vertical joint	$F_{V\perp}$	[kN]	0,2	0,3
Displacements under shear load ¹⁾	$\delta_{V\perp 0}$	[mm]	0,30	0,80
	$\delta_{V\perp \infty}$		0,45	1,20

¹⁾ Shear displacements do not consider the fixture hole clearance and the respective screw position. Clearance hole displacements can be avoided with the use of the Hilti filling set.

Hilti screw anchor HUS4

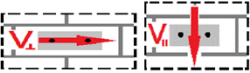
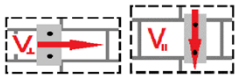
Performances

Essential characteristics under static and quasi-static load in autoclaved aerated concrete bricks

Annex C16

Table C30: Resistance to fire

Fastener size HUS4				8	10
Type				H(F), C	H(F), C, A(F)
Nominal embedment depth		h_{nom}	[mm]	60	75
Characteristic resistance to pullout and brick failure $N_{RK,fi} = N_{RK,p,fi} = N_{RK,b,fi}$					
Mean compressive brick strength $f_{mean} \geq 4$ MPa ($\rho \geq 0,55 \text{ kg/dm}^3$)	R30, R60, R90	$N_{RK,fi}$	[kN]	No performance assessed	0,1
	R120	$N_{RK,fi}$	[kN]		0,1
Mean compressive brick strength $f_{mean} \geq 6$ MPa ($\rho \geq 0,65 \text{ kg/dm}^3$)	R30, R60, R90	$N_{RK,fi}$	[kN]	0,1	0,2
	R120	$N_{RK,fi}$	[kN]	0,1	0,2
Characteristic resistance to brick breakout failure $N^g_{RK,b,fi}$ for double screw anchor groups					
Mean compressive brick strength $f_{mean} \geq 4$ MPa ($\rho \geq 0,55 \text{ kg/dm}^3$)	R30, R60, R90	$N^g_{RK,b,fi}$	[kN]	No performance assessed	0,4
	R120	$N^g_{RK,b,fi}$	[kN]		0,3
Mean compressive brick strength $f_{mean} \geq 6$ MPa ($\rho \geq 0,65 \text{ kg/dm}^3$)	R30, R60, R90	$N^g_{RK,b,fi}$	[kN]	0,3	0,7
	R120	$N^g_{RK,b,fi}$	[kN]	0,2	0,5
Edge distance and spacing					
Minimum edge distance		$c_{min,fi} = c_{j,fi}$	[mm]	120	150
Minimum spacing		$s_{min,fi}$	[mm]	106	106

Hilti screw anchor HUS4

Performances

Essential characteristics under fire exposure in autoclaved aerated concrete bricks

Annex C17

Eine vom Bund und den Ländern gemeinsam
getragene Anstalt des öffentlichen Rechts

Europäische Technische
Bewertungsstelle für Bauprodukte



Europäische Technische Bewertung

ETA-23/0936
vom 13. Mai 2025

Allgemeiner Teil

Technische Bewertungsstelle, die die Europäische Technische Bewertung ausstellt

Handelsname des Bauprodukts

Produktfamilie,
zu der das Bauprodukt gehört

Hersteller

Herstellungsbetrieb

Diese Europäische Technische Bewertung enthält

Diese Europäische Technische Bewertung wird ausgestellt gemäß der Verordnung (EU) Nr. 305/2011, auf der Grundlage von

Deutsches Institut für Bautechnik

Hilti Betonschraube HUS4

Schrauben zur Verankerung im Mauerwerk

Hilti AG Liechtenstein
Feldkircherstraße 100
9494 Schaan
FÜRSTENTUM LIECHTENSTEIN

Hilti Werke

33 Seiten, davon 3 Anhänge, die fester Bestandteil dieser Bewertung sind.

EAD 330460-00-0604, Edition 08/2022

Die Europäische Technische Bewertung wird von der Technischen Bewertungsstelle in ihrer Amtssprache ausgestellt. Übersetzungen dieser Europäischen Technischen Bewertung in andere Sprachen müssen dem Original vollständig entsprechen und müssen als solche gekennzeichnet sein.

Diese Europäische Technische Bewertung darf, auch bei elektronischer Übermittlung, nur vollständig und ungekürzt wiedergegeben werden. Nur mit schriftlicher Zustimmung der ausstellenden Technischen Bewertungsstelle kann eine teilweise Wiedergabe erfolgen. Jede teilweise Wiedergabe ist als solche zu kennzeichnen.

Die ausstellende Technische Bewertungsstelle kann diese Europäische Technische Bewertung widerrufen, insbesondere nach Unterrichtung durch die Kommission gemäß Artikel 25 Absatz 3 der Verordnung (EU) Nr. 305/2011.

Besonderer Teil

1 Technische Beschreibung des Produkts

Die Hilti Betonschraube HUS4 ist ein Dübel in den Größen 8 und 10 mm aus galvanisch verzinktem Kohlenstoffstahl oder Kohlenstoffstahl mit mehrlagiger Beschichtung. Der Dübel wird in ein vorgebohrtes zylindrisches Bohrloch geschraubt. Das Spezialgewinde schneidet während des Setzvorgangs ein Innengewinde in den Verankerungsgrund. Die Verankerung erfolgt durch Formschluss des Spezialgewindes.

Die Produktbeschreibung ist in Anhang A angegeben.

2 Spezifizierung des Verwendungszwecks gemäß dem anwendbaren Europäischen Bewertungsdokument

Von den Leistungen in Abschnitt 3 kann nur ausgegangen werden, wenn der Dübel entsprechend den Angaben und unter den Randbedingungen nach Anhang B verwendet wird.

Die Prüf- und Bewertungsmethoden, die dieser Europäischen Technischen Bewertung zu Grunde liegen, führen zur Annahme einer Nutzungsdauer des Dübels von mindestens 50 Jahren. Die Angabe der Nutzungsdauer kann nicht als Garantie des Herstellers verstanden werden, sondern ist lediglich ein Hilfsmittel zur Auswahl des richtigen Produkts in Bezug auf die angenommene wirtschaftlich angemessene Nutzungsdauer des Bauwerks.

3 Leistung des Produkts und Angaben der Methoden ihrer Bewertung

3.1 Mechanische Festigkeit und Standsicherheit (BWR 1)

Wesentliches Merkmal	Leistung
Charakteristischer Widerstand eines einzelnen Schraubankers gegen Stahlversagen unter Zugbeanspruchung	$N_{Rk,s}$ siehe Anhang C1
Charakteristischer Widerstand eines einzelnen Schraubankers gegen Stahlversagen unter Querbeanspruchung	$V_{Rk,s}$ [kN], $M^0_{Rk,s}$ siehe Anhang C1
Charakteristischer Widerstand eines einzelnen Schraubankers gegen Herausziehen oder Ausbruch des Mauersteins unter Zugbeanspruchung	$N_{Rk,p}$, $N_{Rk,b}$, $N_{Rk,p,c}$, $N_{Rk,b,c}$ siehe Anhang B7, C3, C7, C11, C15 $\alpha_{j,N}$ siehe Anhang C3, C7, C11, C15
Charakteristischer Widerstand eines einzelnen Schraubankers gegen örtliches Versagen oder Kantenbruch des Mauersteins unter Querbeanspruchung	$V_{Rk,b,II}$, $V_{Rk,b,\perp}$, $V_{Rk,c,II}$, $V_{Rk,c,\perp}$ siehe Anhang B7, C3, C7, C11, C15 $\alpha_{j,VII}$, $\alpha_{j,V\perp}$ siehe Anhang C3, C7, C11, C15
Charakteristischer Widerstand einer Schraubankergruppe gegen Ausbruch des Mauersteins unter Zugbeanspruchung	N^g_{Rk} siehe Anhang B7 $\alpha_{g,N}$ siehe Anhang B7, C4, C8, C12, C16
Charakteristischer Widerstand einer Schraubankergruppe gegen örtliches Versagen oder Kantenbruch des Mauersteins unter Querbeanspruchung	$V^g_{Rk,b,II}$, $V^g_{Rk,b,\perp}$, $V^g_{Rk,c,II}$, $V^g_{Rk,c,\perp}$ siehe Anhang B7 $\alpha_{g,VII}$, $\alpha_{g,VII\perp}$ siehe Anhang B7, C4, C8, C12, C16

Wesentliches Merkmal	Leistung
Randabstand, Abstand zur Fuge, Achsabstand, Bauteildicke	C_{cr} , S_{crII} , $S_{cr\perp}$ siehe Anhang B7, C2, C6, C10, C14 C_{min} , C_{jII} , $C_{j\perp}$, S_{minII} , $S_{min\perp}$ siehe Anhang C2, C6, C10, C14 h_{min} siehe Anhang C2, C6, C10, C14
Charakteristische Widerstand unter kombinierter Zug- und Querbeanspruchung (Hohl- und Lochsteine)	Keine Leistung bewertet
Verschiebungen	δ_{N0} , $\delta_{N\infty}$, δ_{V0} , $\delta_{V\infty}$ siehe Anhang C4, C8, C12, C16

3.2 Brandschutz (BWR 2)

Wesentliches Merkmal	Leistung
Brandverhalten	Klasse A1
Feuerwiderstand	$N_{Rk,s,fi}$, $N_{Rk,p,fi}$, $N_{Rk,b,fi}$, $V_{Rk,s,fi}$, $M^0_{Rk,s,fi}$, $C_{min,fi}$, $C_{j,fi}$ siehe Anhang C1, C5, C9, C13, C17 $N_{Rk,fi}$, $S_{min,fi}$, $C_{min,fi}$, $C_{j,fi}$ siehe Anhang C1, C5, C9, C13, C17

3.3 Aspekte der Dauerhaftigkeit

Wesentliches Merkmal	Leistung
Dauerhaftigkeit	Siehe Anhang B1

4 Angewandtes System zur Bewertung und Überprüfung der Leistungsbeständigkeit mit der Angabe der Rechtsgrundlage

Gemäß dem Europäischen Bewertungsdokument EAD Nr. 330460-00-0604 gilt folgende Rechtsgrundlage: [97/177/EG].

Folgendes System ist anzuwenden: 1

5 Für die Durchführung des Systems zur Bewertung und Überprüfung der Leistungsbeständigkeit erforderliche technische Einzelheiten gemäß anwendbarem Europäischen Bewertungsdokument

Technische Einzelheiten, die für die Durchführung des Systems zur Bewertung und Überprüfung der Leistungsbeständigkeit notwendig sind, sind Bestandteil des Prüfplans, der beim Deutschen Institut für Bautechnik hinterlegt ist.

Ausgestellt in Berlin am 13. Mai 2025 vom Deutschen Institut für Bautechnik

Dipl.-Ing. Beatrix Wittstock
Referatsleiterin

Beglaubigt:
Aksünger

Einbauzustand ohne Adjustierung

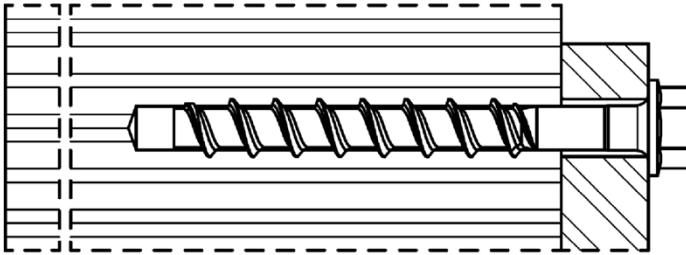

HUS4-H (Ausführung Sechskantkopf
Größen 8 und 10)
HUS4-HF (Ausführung Sechskantkopf
Größen 8 und 10)

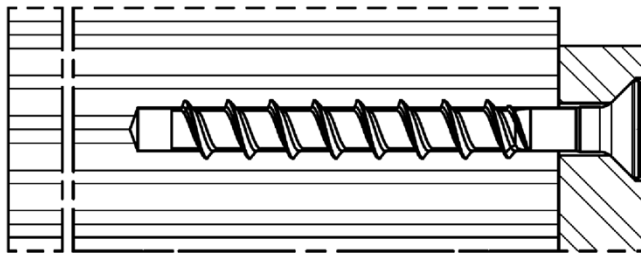

HUS4-C (Ausführung mit Senkkopf
Größen 8 und 10)

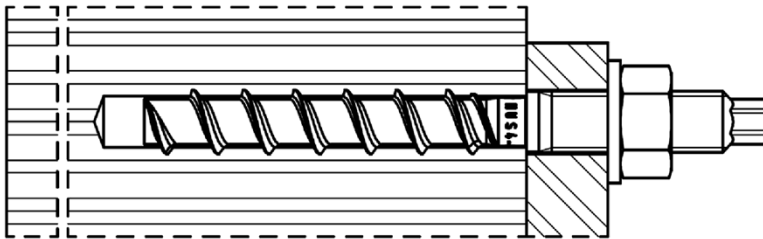

HUS4-A
(Ausführung Außengewinde
Größe 10)
HUS4-AF
(Ausführung Außengewinde
Größe 10)

Einbauzustand mit Adjustierung

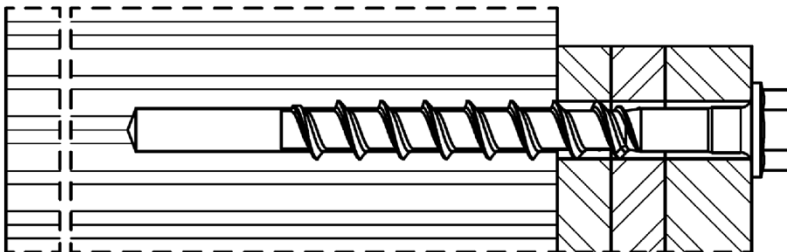

HUS4-H (Ausführung Sechskantkopf
Größen 8 und 10)
HUS4-HF (Ausführung Sechskantkopf
Größen 8 und 10)

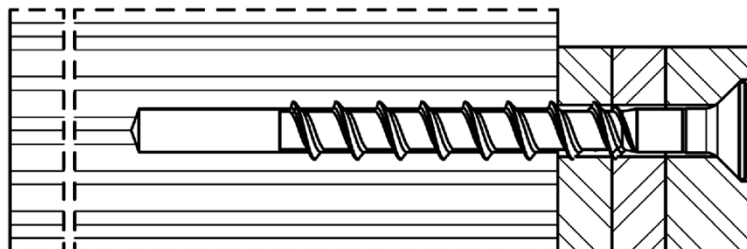

HUS4-C (Ausführung mit Senkkopf
Größen 8 und 10)

Hilti Betonschraube HUS4

Produktbeschreibung
Einbauzustand mit und ohne Adjustierung

Anhang A1

Tabelle A1: Schraubenausführungen

Hilti HUS4-H, Größe 8 und 10, Ausführung mit Sechskantkopf, Kohlenstoffstahl galvanisch verzinkt
Hilti HUS4-HF, Größe 8 und 10, Ausführung mit Sechskantkopf, Kohlenstoffstahl mehrlagige Beschichtung

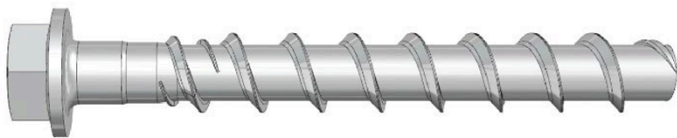

Hilti HUS4-C, Größe 8 und 10, Ausführung mit Senkkopf, Kohlenstoffstahl galvanisch verzinkt

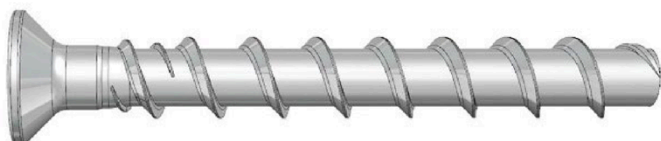

Hilti HUS4-A, Größe 10 mit Außengewinde M12, Kohlenstoffstahl galvanisch verzinkt
Hilti HUS4-AF, Größe 10 mit Außengewinde M12, Kohlenstoffstahl mehrlagige Beschichtung



Hilti Betonschraube HUS4

Produktbeschreibung
HUS4 Schraubenausführungen

Anhang A2

Tabelle A2: Hilti Verfüll-Set (für HUS4 (T)-H(F, R) und HUS4-A(F)) und Hilti Injektionsmörtel





Verschlusscheibe	Kugelscheibe	Injektionsmörtel
		 <p>Hilti HIT-HY ... mit ETA Hilti HIT-RE ... mit ETA</p>

Tabelle A3: Material

Teil	Material
HUS4-H(F), HUS4-C und HUS4-A(F) Betonschraube	Kohlenstoffstahl Bruchdehnung $A_5 \leq 8\%$
Hilti Verfüll-Set (Kohlenstoffstahl)	Verschlusscheibe: Kohlenstoffstahl Kugelscheibe: Kohlenstoffstahl

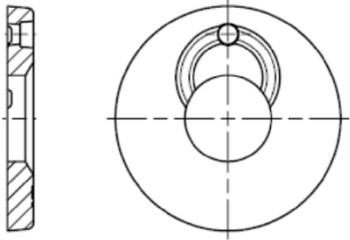
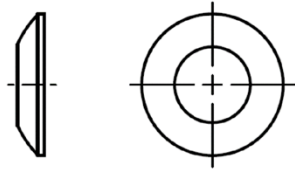
Tabelle A4: Abmessungen Verfüll-Set und Kompatibilität

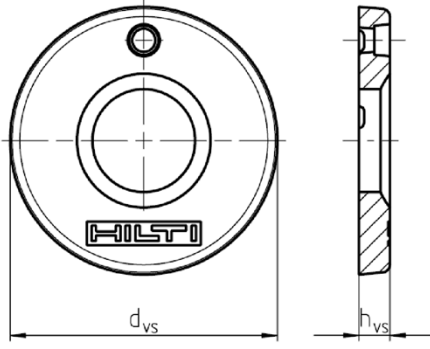
Größe Verfüll-Set	M10	M12	
Durchmesser der Dichtungsscheibe d_{vs} [mm]	42	44	
Höhe der Dichtungsscheibe h_{vs} [mm]	5	5	
Höhe des Verfüll-Sets h_{fs} [mm]	9	10	
HUS4-H (F, R) 	8	10	
HUS4-A (F) 	-	10	



Hilti Betonschraube HUS4

Produktbeschreibung
Verfüll-Set und Hilti Injektionsmörtel, Materialien

Anhang A3

Tabelle A5: Abmessungen und Markierung HUS4-A(F)

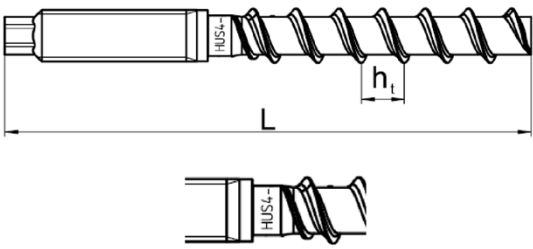
Größe HUS4-			A(F) 10
Nomineller Dübeldurchmesser	d	[mm]	10
Außengewindeanschluss			M12
Gewindesteigung	h_t	[mm]	10
Länge des Dübels im Beton	h_{nom}	[mm]	75
Länge der Schraube min / max			120 / 165

 <p>z.B. HUS4-A 10x165</p>		HUS4: Hilti Universal Schraube 4. Generation			
		A: Außengewinde, galvanisch verzinkt			
			AF: Außengewinde, mehrlagige Beschichtung		
			10: Nomineller Schraubendurchmesser d [mm]		
			165: Länge der Schraube L [mm]		
			8: Kohlenstoffstahl		
			K: Längenidentifikation HUS4-A 10x165		
			G	I	K
			10x120	10x140	10x165

Hilti Betonschraube HUS4

Produktbeschreibung
Abmessungen und Markierung

Anhang A4

Tabelle A6: Abmessungen und Kopfmarkierung HUS4-H(F)

Größe HUS4			H(F) 8	H(F) 10
Nomineller Dübeldurchmesser	d	[mm]	8	10
Gewindesteigung	h_t	[mm]	8	10
Länge des Dübels im Beton	h_{nom}	[mm]	60	75
Länge der Schraube min / max	L	[mm]	65 / 150	80 / 305

	HUS4: Hilti Universal Schraube 4. Generation
	H: Sechskantkopf, galvanisch verzinkt
	HF: Sechskantkopf, mehrlagige Beschichtung
	10: Nomineller Schraubendurchmesser d [mm]
	100: Länge der Schraube [mm]

Tabelle A7: Abmessungen und Kopfmarkierung HUS4-C

Fastener size HUS4-			C 8	C 10
Nomineller Dübeldurchmesser	d	[mm]	8	10
Gewindesteigung	h_t	[mm]	8	10
Länge des Dübels im Beton	h_{nom}	[mm]	60	75
Länge der Schraube min / max	L	[mm]	65 / 160	80 / 120

	HUS4: Hilti Universal Schraube 4. Generation
	C: Senkkopf, galvanisch verzinkt
	10: Nomineller Schraubendurchmesser d [mm]
	100: Länge der Schraube L [mm]

Hilti Betonschraube HUS4

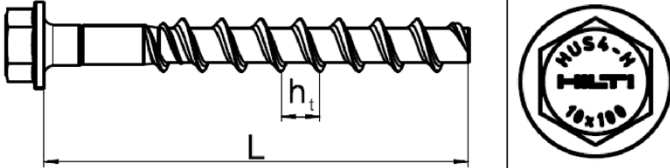
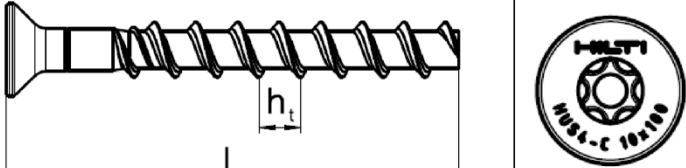
Produktbeschreibung
Abmessungen und Markierung

Anhang A5

Spezifizierung des Verwendungszwecks

Beanspruchung der Verankerung:

- Statische und quasi-statische Belastung
- Brandbeanspruchung (nur für trockenes Mauerwerk)

Verankerungsgrund:

- Mauerwerk aus Vollstein, nach Anhang B2
- Horizontale Fugen müssen vollständig mit Mörtel verfüllt sein. Vertikale Fugen können, müssen aber nicht mit Mörtel verfüllt werden. Festigkeitsklasse des Mauermörtels: M2,5 oder höher, entsprechend EN 998-2:2016.
- Unter Brandbeanspruchung alle Fugen müssen vollständig mit Mörtel gefüllt sein. Festigkeitsklasse des Mauermörtels: M2,5 oder höher, entsprechend EN 998-2:2016.
- Maximale Fugenbreite w_j siehe Anhang C3, C7, C11, C15
- Wandherstellung und Fugenmaße gemäß EN 1996-1-1:2022.
- Trockenes oder nasses Mauerwerk (bei der Installation)

Anwendungsbedingungen (Umweltbedingungen):

- Bauteile unter den Bedingungen trockener Innenräume: alle Schraubenausführungen
- Temperaturbereich des Mauerwerks während der Nutzungsdauer: -40 °C bis +80 °C

Bemessung:

- Die Befestigungen müssen unter der Verantwortung eines auf dem Gebiet der Verankerungen und des Betonbaus erfahrenen Ingenieurs bemessen werden.
- Unter Berücksichtigung der zu verankernden Lasten sind prüfbare Berechnungen und Konstruktionszeichnungen anzufertigen. Auf den Konstruktionszeichnungen ist die Lage des Dübels (z. B. Lage des Dübels zur Bewehrung oder zu den Auflagern usw.) anzugeben.
- Die Bemessung der Verankerungen erfolgt in Übereinstimmung mit EOTA Technical Report TR054: Juli 2022.
- Für Vollziegel gelten die charakteristischen Festigkeiten auch für Ziegel mit größeren Abmessungen, höherer mittlere Druckfestigkeit oder größerer spezifischer Masse.

Einbau:





- Der Verankerung durch entsprechend geschulten Personals und unter der Aufsicht des Bauleiters.
- Bei Fehlbohrungen: Anordnung eines neuen Bohrlochs in einem Abstand, der mindestens der doppelten Tiefe der Fehlbohrung entspricht, oder in geringerem Abstand, wenn die Fehlbohrung mit hochfestem Mörtel verfüllt wird und wenn sie bei Quer- oder Schrägzuglast nicht in Richtung der aufgebracht Last liegt.
- Nach der Montage darf ein leichtes Weiterdrehen des Dübels nicht möglich sein.
- Der Dübelkopf (HUS4-H(F) und HUS4-C) muss am Anbauteil anliegen und darf nicht beschädigt sein.
- Das Hilti Verfüll-Set darf mit HUS4-H(F) und HUS4-A(F) verwendet werden.
- Der minimal zulässige Abstand von den Fugen ist in den Anhängen C3, C6, C9 and C12 festgelegt.
- Bohrmethode: Hammerschlagbohrung oder rotatorische Bohrung mit Standard-Hammerschlagbohrern oder Hohlbohrern in gereinigten und ungereinigten Bohrlöchern. Im Falle eines ungereinigten Bohrlochs muss dreimalige Belüftung angewendet werden.
- Adjustierbarkeit nach Anhang B2.

Hilti Betonschraube HUS4

Verwendungszweck
Spezifikationen

Anhang B1

Tabelle B1: Übersicht Mauersteinarten, Eigenschaften und Befestigungselemente

Art des Mauersteins	Foto	Stein- abmessungen ¹⁾ [mm]	Marken- namen ¹⁾ , e.g.	Mittlere Druck- Festigkeit $f_{\text{mean}}^{1)}$ [N/mm ²]	HUS4- H(F), C, HF 8	HUS4- A, H(F), C 10	Anhang
Vollziegel EN 771-1		≥ 240x115x52	Mz 1DF Mz NF Mz 2DF Rosso Vivo, Rosso Classico	18 / 27	$h_{\text{nom}} = 60$	$h_{\text{nom}} = 75$	C2
Kalksand- vollstein EN 771-2		≥ 240x115x113	KS 2DF	20 / 30	$h_{\text{nom}} = 60$	$h_{\text{nom}} = 75$	C6
Leichtbeton- vollstein EN 771-3		≥ 498x150x199	LECA murblock	5 / 7,5	$h_{\text{nom}} = 60$	$h_{\text{nom}} = 75$	C10
Porenbeton- stein PPW 6-0,4 EN 771-4		≥ 499x240x249	Xella Ytong Therm-Combi	4 / 6	$h_{\text{nom}} = 60$	$h_{\text{nom}} = 75$	C14

¹⁾ Die charakteristischen Festigkeiten auch für Ziegel mit größeren Abmessungen, höherer Druckfestigkeit oder größerer spezifischer Masse

Table B2: Spezifikation der Adjustierbarkeit für HUS4 in Mauerwerk

Größe HUS4			8	10
Typ			H(F), C	H(F), C, A(F)
Länge des Dübels im Beton	h_{nom}	[mm]	60	75
Adjustierung				
Max. Dicke der Unterfütterung	t_{adj}	[mm]	10	10
Max. Anzahl der Adjustierungen	n_a	[-]	2	2

Hilti Betonschraube HUS4

Verwendungszweck
Übersicht der Steinarten und Befestigungselemente

Anhang B2

Montagekennwerte

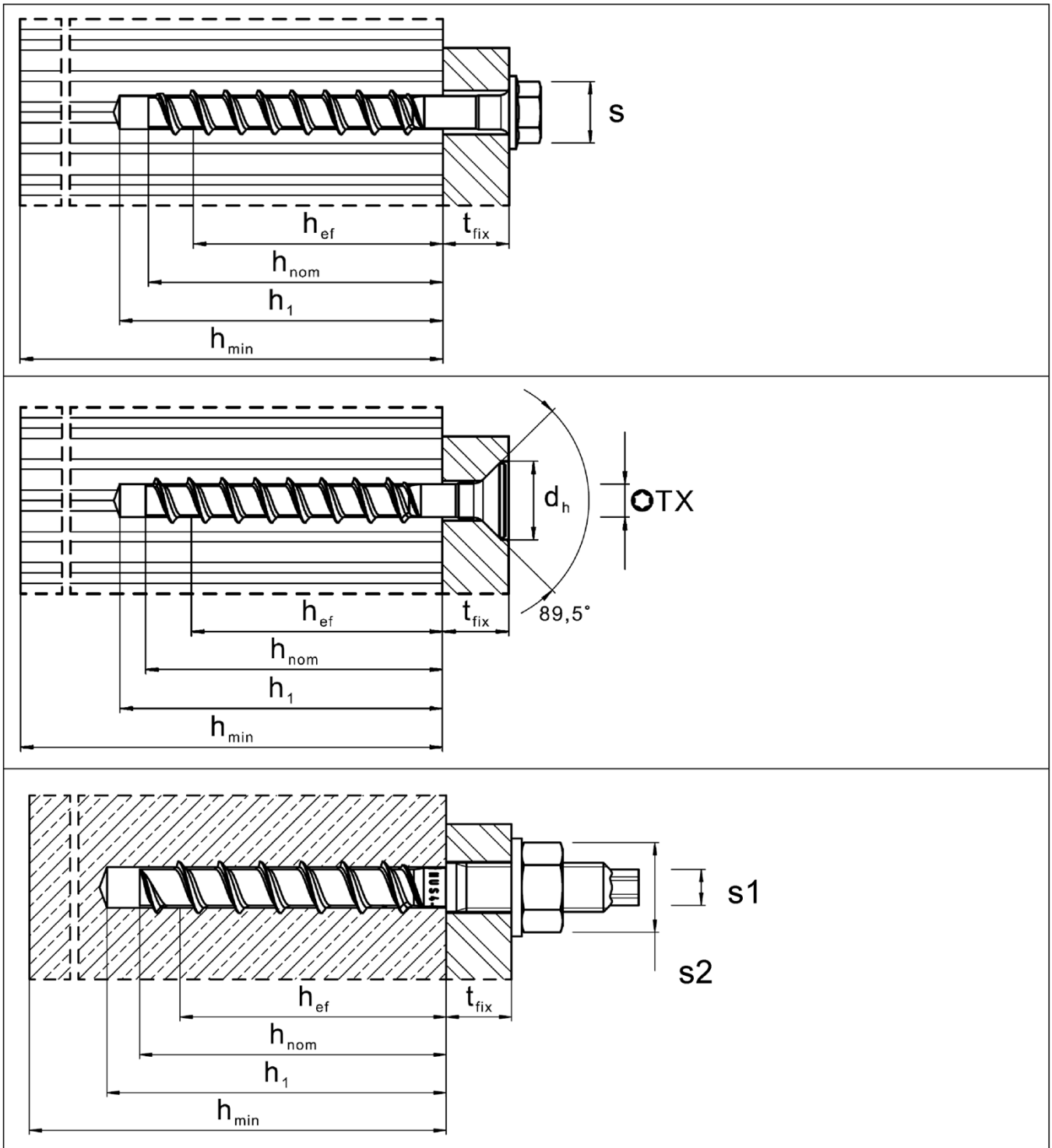

Hilti Betonschraube HUS4

Verwendungszweck
Montagekennwerte

Anhang B3

Tabelle B3: Montagekennwerte HUS4 Größe 8 und 10

Größe HUS4			8	10
Typ			H(F), C	H(F), C, A(F)
Länge des Dübels im Beton	h_{nom}	[mm]	60	75
Bohrerinnendurchmesser	d_0	[mm]	8	10
Bohrerschneidendurchmesser	$d_{cut} \leq$	[mm]	8,45	10,45
Durchgangsloch im Anbauteil Durchsteckmontage	$d_f \frac{min}{max}$	[mm]	11	13
			12	14
Durchgangsloch im Anbauteil Vorsteckmontage (A-Typ)	$d_f \leq$	[mm]	-	14
Schlüsselweite (H, HF- Typ)	s	[mm]	13	15
Schlüsselweite für den Sechskantkopf (A-Typ)	s1	[mm]	-	8
Schlüsselweite für die Mutter (A- Typ)	s2	[mm]	-	19
Torx-Größe (C-Typ)	TX	-	45	50
Durchmesser Senkkopf	d_h	[mm]	18	21
Bohrlochtiefe für gereinigte Bohrlöcher Hammerbohren oder ungereinigt Hammerbohren Überkopf	$h_1 \geq$	[mm]	(h _{nom} + 10 mm)	
			70	85
Bohrlochtiefe für ungereinigte Bohrlöcher Hammerbohren in Wand und Bodenposition	$h_1 \geq$	[mm]	(h _{nom} + 10 mm) + 2 * d ₀	
			86	105
Bohrlochtiefe (mit Adjustierung) für gereinigte Bohrlöcher Hammerbohren oder ungereinigt Hammerbohren Überkopf	$h_1 \geq$	[mm]	(h _{nom} + 20 mm)	
			80	95
Bohrlochtiefe (mit Adjustierung) für ungereinigte Bohrlöcher Hammerbohren in Wand und Bodenposition	$h_1 \geq$	[mm]	(h _{nom} + 20 mm) + 2 * d ₀	
			96	115
Minimaler Achsabstand	$s_{min} \geq$	[mm]	80	80

Hilti Betonschraube HUS4

Verwendungszweck
Montagekennwerte

Anhang B4

Setzanweisung

Bohrlocherstellung und Reinigung

Hammerbohren (HD) alle Größen für Kohlenstoffstahl und Schraubentypen

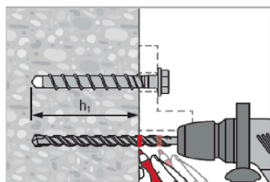

Erforderliche Bohrtiefe h_1 für Durchsteckmontage oder Vorsteckmontage auf dem Bohrer markieren.
Details zur Bohrlochtiefe h_1 siehe Tabelle B2.

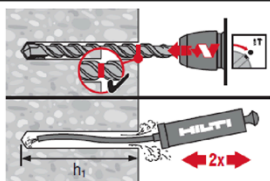

Reinigung des Bohrlochs zur Montage in Wand oder Bodenposition mit Bohrtiefe $h_1 = h_{nom} + 10 \text{ mm}$

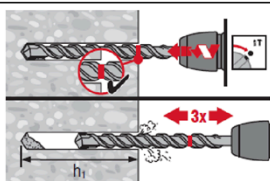

Es ist keine Reinigung erforderlich, wenn vertikal nach unten oder horizontal gebohrt und nach dem Bohren dreimal gelüftet¹⁾ wird.

Bohrlochtiefe $h_1 = h_{nom} + 10 \text{ mm} + 2 * d_0$

¹⁾ Den Bohrer dreimal aus dem Bohrloch ziehen und wieder hineinschieben, nachdem die empfohlene Bohrlochtiefe h_1 erreicht wurde. Dieses Vorgehen soll sowohl im Drehmodus wie auch im Hammermodus der Bohrmaschine durchgeführt werden. Genauere Informationen sind in der relevanten Gebrauchsanweisung (MPII) enthalten.

Hilti Betonschraube HUS4

Verwendungszweck
Setzanweisung

Anhang B5

Schraubeninstallation ohne Adjustierung

Maschinensetzen

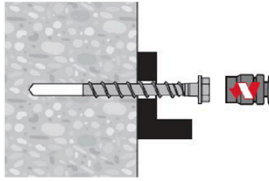

Installation der Schraube mit Werkzeugen und Montagekennwerte aufgelistet in Tabelle B2.

Kontrolle der Setzung

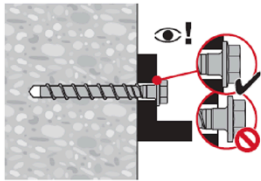

Setzen des Dübels mit Adjustierung

Adjustierung

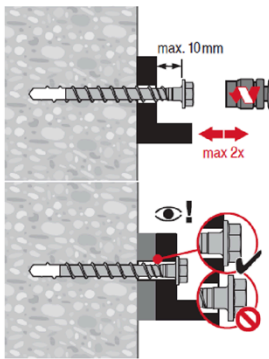

Der Dübel darf maximal zweimal adjustiert werden. Die bei der Adjustierung erfolgte Unterfütterung darf insgesamt maximal 10 mm betragen. Die erforderliche Setztiefe h_{nom} muss nach der Adjustierung eingehalten werden.

Setzen des Dübels mit Hilti Verfüll-Set



Injektion des Hilti HIT Mörtels und Aushärtezeit

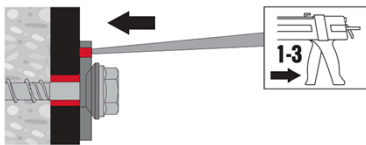

Ringspalt zwischen Stahlelement und Anbauteil mit einem Hilti Injektionsmörtel HIT-HY --- oder HIT-RE ... mit 1 bis 3 Hieben verfüllen. Befolgen Sie die Bedienungsanleitung, die dem entsprechenden Hilti Injektionsmörtel beigelegt ist. Nach Ablauf der erforderlichen Aushärtezeit t_{cure} kann die Befestigung belastet werden.

Hilti Betonschraube HUS4

Verwendungszweck
Setzanweisung

Anhang B6

Definition der Montageposition und der Abstände

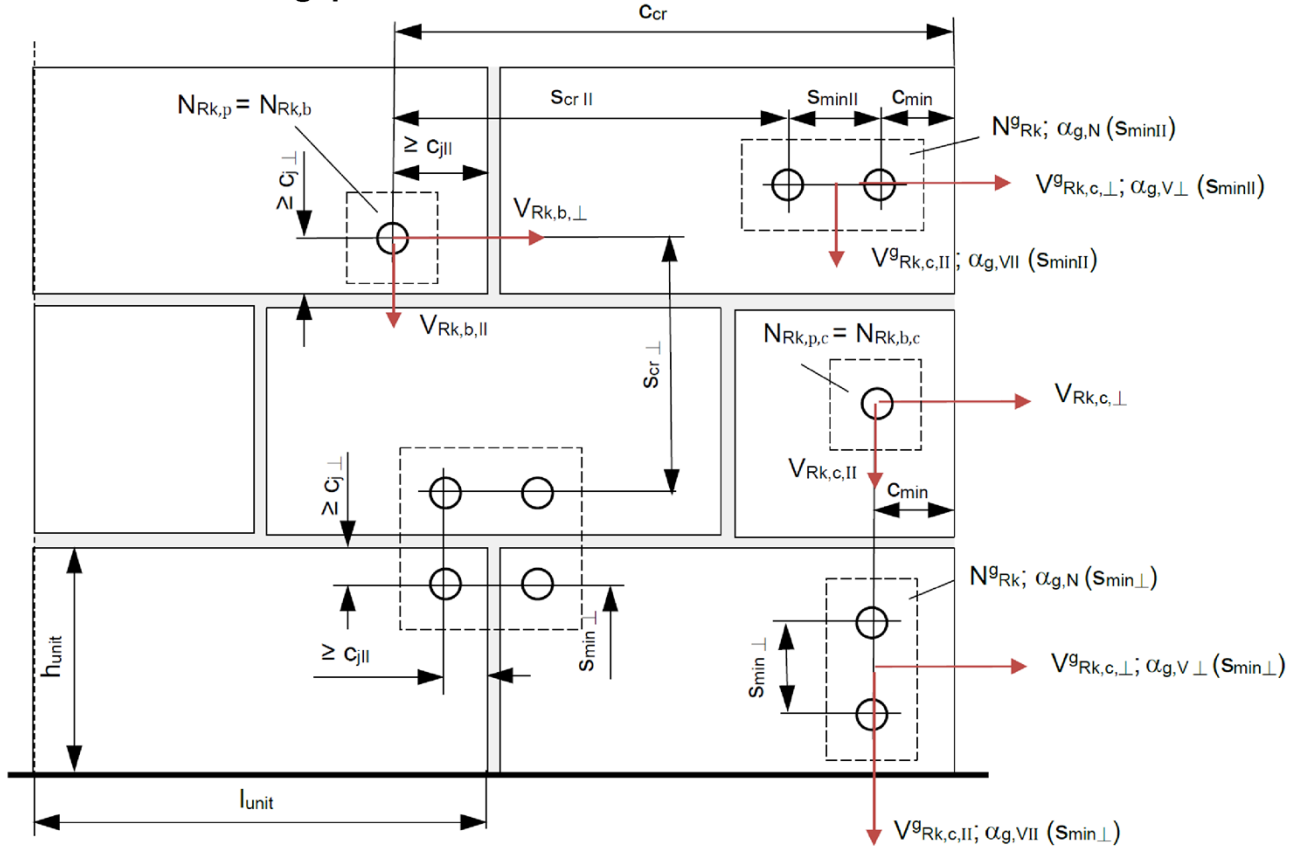

- C_{min} = minimaler Randabstand zum freien Rand
- $C_{j||}$ = Abstand zu Stossfugen für Tragfähigkeit des Schraubankers ohne Fugeneinfluss
- $C_{j\perp}$ = Abstand zu Lagerfugen für Tragfähigkeit des Schraubankers ohne Fugeneinfluss
- C_{cr} = Randabstand zur Übertragung des charakteristischen Widerstands eines einzelnen Schraubankers
- $s_{min||}$ = minimaler Achsabstand parallel zur Lagerfuge
- $s_{min\perp}$ = minimaler Achsabstand senkrecht zur Lagerfuge
- $s_{cr||}$ = charakteristischen Achsabstand parallel zur Lagerfuge
- $s_{cr\perp}$ = charakteristischen Achsabstand senkrecht zur Lagerfuge
- l_{unit} = Steinlänge
- h_{unit} = Steinhöhe
- w_j = Maximale Fugenbreite
- $\alpha_{g,N}$ = Gruppenfaktor bei Zuglast bei minimalen Achsabstand ($\alpha_{g,N} = \alpha_{g,N}(s_{min||}) = \alpha_{g,N}(s_{min\perp})$)
- $\alpha_{g,V||}$ = Gruppenfaktor bei Querlast parallel zu dem Rand
- $\alpha_{g,V\perp}$ = Gruppenfaktor bei Querlast senkrecht zu dem Rand

$$N_{Rk} = N_{Rk,b} = N_{Rk,p} = N_{Rk,b,c} = N_{Rk,p,c}$$

$$V_{Rk,||} = V_{Rk,b,||} = V_{Rk,c,||}; \quad V_{Rk,\perp} = V_{Rk,b,\perp} = V_{Rk,c,\perp}$$

$$\text{For } s \geq s_{cr}: \alpha_{g,N} = \alpha_{g,V,||} = \alpha_{g,V,\perp} = 2$$

$$\text{For } s_{min} \leq s \leq s_{cr}: \alpha_{g,N}; \alpha_{g,V,||}; \alpha_{g,V,\perp}$$

entsprechend Montagekennwerte der Steine im Anhang C

$$N_{Rk}^g = \alpha_{g,N} \cdot N_{Rk}$$

(Gruppe von 2 Ankern)

$$V_{Rk,||}^g(s_{min||}) = \alpha_{g,V||}(s_{min||}) \cdot V_{Rk,||}; \quad V_{Rk,||}^g(s_{min\perp}) = \alpha_{g,V||}(s_{min\perp}) \cdot V_{Rk,||}$$

(Gruppe von 2 Ankern)

$$V_{Rk,\perp}^g(s_{min||}) = \alpha_{g,V\perp}(s_{min||}) \cdot V_{Rk,\perp}; \quad V_{Rk,\perp}^g(s_{min\perp}) = \alpha_{g,V\perp}(s_{min\perp}) \cdot V_{Rk,\perp}$$

(Gruppe von 2 Ankern)

$$N_{Rk}^g = \alpha_{g,N}^2 \cdot N_{Rk}$$

(Gruppe von 4 Ankern)

$$V_{Rk,||}^g = \alpha_{g,V||}(s_{min||}) \cdot \alpha_{g,V||}(s_{min\perp}) \cdot V_{Rk,||}; \quad V_{Rk,\perp}^g = \alpha_{g,V\perp}(s_{min||}) \cdot \alpha_{g,V\perp}(s_{min\perp}) \cdot V_{Rk,\perp}$$

(Gruppe von 4 Ankern)

Hilti Betonschraube HUS4

Verwendungszweck

Definition der Montageposition und der Abstände

Anhang B7

Table C1: Charakteristischer Widerstand eines einzelnen Schraubankers gegen Stahlversagen unter Zug - und Querbeanspruchung

Größe HUS4 Typ		8 H(F), C	10 H(F), C, A(F)
Stahlversagen unten Zugbeanspruchung			
Charakteristischer Widerstand	$N_{Rk,s}$ [kN]	36,0	55,0
Teilsicherheitsbeiwert	$\gamma_{Ms,N}^{1)}$ [-]	1,5	1,5
Stahlversagen unten Querbeanspruchung			
Charakteristischer Widerstand	$V^0_{Rk,s}$ [kN]	18,8	28,8
Teilsicherheitsbeiwert	$\gamma_{Ms,V}^{1)}$ [-]	1,25	
Duktilitätsfaktor	k_7 [-]	0,8	
Charakteristischer Widerstand	$M^0_{Rk,s}$ [Nm]	32	64

¹⁾ Sofern andere nationale Regelungen fehlen.

Table C2: Feuerwiderstand

Größe HUS4 Typ		8 H(F), C	10 H(F), C, A(F)	
Länge des Dübels im Beton	h_{nom} [mm]	60	75	
Stahlversagen unter Zug- und Querbeanspruchung unter Brandbeanspruchung				
Charakteristischer Widerstand	R30	$N_{Rk,s,fi} = V_{Rk,s,fi}$ [kN]	0,47	1,03
	R60	$N_{Rk,s,fi} = V_{Rk,s,fi}$ [kN]	0,42	0,89
	R90	$N_{Rk,s,fi} = V_{Rk,s,fi}$ [kN]	0,33	0,68
	R120	$N_{Rk,s,fi} = V_{Rk,s,fi}$ [kN]	0,23	0,55
	R30	$M^0_{Rk,s,fi}$ [Nm]	0,42	1,20
	R60	$M^0_{Rk,s,fi}$ [Nm]	0,37	1,04
	R90	$M^0_{Rk,s,fi}$ [Nm]	0,29	0,80
	R120	$M^0_{Rk,s,fi}$ [Nm]	0,21	0,64

Hilti Betonschraube HUS4

Leistung

Wesentliche Merkmale unter statischer und quasi-statischer Last und Brandbeanspruchung

Anhang C1

Art des Mauersteins: Vollziegel

Tabelle C3: Beschreibung des Mauersteins

Steintyp		[-]	Vollstein	
Rohdichte	ρ	[kg/dm ³]	1,5	
Mittlere Druckfestigkeit	f_{mean}	[N/mm ²]	≥ 18	
Norm		[-]	EN 771-1:2011	
Steinabmessungen	$l \times b \times h$	[mm]	≥ 240 x 115 x 52	
Minimale Wanddicke	h_{min}	[mm]	≥ 115	

Table C4: Installationsparameter

Größe HUS4			8	10
Typ			H(F), C	H(F), C, A(F)
Installationsparameter				
Länge des Dübels im Beton	h_{nom}	[mm]	60	75
Setzwerkzeug: Bohrschrauber und Leistungsbegrenzung			[-]	
Setzwerkzeug: Bohrschrauber und Leistungsbegrenzung			Darf nicht verwendet werden	
Setzwerkzeug:	Typ und Leistungsbegrenzung		SIW 4AT-22 Gear 1	SIW 4AT-22 Gear 1
Schlagschrauber und Leistungsbegrenzung	Maximale Drehmoment gemäß Herstellerangabe		[Nm]	90
Rand- und Achsabstände				
Minimaler Randabstand zum freien Rand	c_{min}	[mm]	1,5 h_{nom}	
Minimaler Achsabstand	$s_{\text{min} \parallel} = s_{\text{min} \perp}$	[mm]	80	
Charakteristischer Randabstand	c_{cr}	[mm]	1,5 h_{nom}	
charakteristischer Achsabstand	s_{cr}	[mm]	3,0 h_{nom}	

¹⁾ Installation mit anderem Schlagschrauber bei gleichwertiger Leistung ist zulässig.

Hilti Betonschraube HUS4

Leistung

Wesentliche Merkmale unter statischer und quasi-statischer Last in Vollziegel

Anhang C2

Table C5: Charakteristischer Widerstand unter Zug- und Querbeanspruchung

Größe HUS4		8		10	
Typ		H(F), C		H(F), C, A(F)	
	Nutzungskategorie	trocken	nass	trocken	nass
Länge des Dübels im Beton	h_{nom} [mm]	60		75	
Charakteristischer Widerstand eines einzelnen Schraubankers gegen Herausziehen oder Ausbruch des Mauersteins unter Zug- und Querbeanspruchung					
	Mittlere Steindruckfestigkeit f_{mean} [MPa]	$N_{Rk} = N_{Rk,b} = N_{Rk,p} = N_{Rk,b,c} = N_{Rk,p,c}$ [kN]			
	≥ 18 MPa	5,5		7,0	
	≥ 27 MPa	6,7		8,5	
Charakteristischer Widerstand eines einzelnen Schraubankers gegen örtliches Versagen oder Kantenbruch des Mauersteins unter Querbeanspruchung					
	Mittlere Steindruckfestigkeit f_{mean} [MPa]	$V_{Rk, } = V_{Rk,b, } = V_{Rk,c, }$ [kN]			
	≥ 18	7,9		11,4	
	≥ 27	9,7		14,0	
	Mittlere Steindruckfestigkeit f_{mean} [MPa]	$V_{Rk,\perp} = V_{Rk,b,\perp} = V_{Rk,c,\perp}$ [kN]			
	≥ 18	4,4		4,4	
	≥ 27	5,3		5,3	

Table C6: Abminderungsfaktoren in Abhängigkeit vom Fugenabstand

Größe HUS4		8		10	
Typ		H(F), C		H(F), C, A(F)	
Länge des Dübels im Beton	h_{nom} [mm]	60		75	
Maximale Fugenbreite	w_j [mm]	10		10	
Abstand zu Fugen	$c_{j,\perp}$ [mm]	≥ 26		≥ 26	
	$c_{j, }$ [mm]	$\geq 1,5 h_{nom}$		$\geq 1,5 h_{nom}$	
Abminderungsfaktor	$\alpha_{j,N}$ [-]	1,0		1,0	
	$\alpha_{j,v, }$ [-]	1,0		1,0	
	$\alpha_{j,v,\perp}$ [-]	1,0		1,0	
Abstand zu Fugen	$c_{j,\perp}$ [mm]	≥ 20		≥ 20	
	$c_{j, }$ [mm]	≥ 20		≥ 20	
Abminderungsfaktor	$\alpha_{j,N}$ [-]	0,88		0,83	
	$\alpha_{j,v, }$ [-]	1,0		1,0	
	$\alpha_{j,v,\perp}$ [-]	1,0		1,0	
Abstand zu Fugen	$c_{j,\perp}$ [mm]	< 20		< 20	
	$c_{j, }$ [mm]	< 20		< 20	
Abminderungsfaktor	$\alpha_{j,N}$ $\alpha_{j,v, } = \alpha_{j,v,\perp}$ [-]	Die Schraube darf nicht verwendet werden			

Hilti Betonschraube HUS4

Leistung

Wesentliche Merkmale unter statischer und quasi-statischer Last in Vollziegel

Anhang C3

Table C7: Gruppenfaktoren für Gruppen von zwei Ankern



Größe HUS4		Anwendung	8	10
Typ			H(F), C	H(F), C, A(F)
Minimale Achsabstand	$s_{min\parallel} = s_{min\perp}$ [mm]	-	80	80
Gruppenfaktoren unter Zuglast	$\alpha_{g,N}(s_{min\parallel}) = \alpha_{g,N}(s_{min\perp})$ [-]		1,70	1,25
Gruppenfaktoren unter Querlast bei minimalem Achsabstand in Richtung parallel zur Lagerfuge	$\alpha_{g,V\perp}(s_{min\parallel}) = \alpha_{g,V\parallel}(s_{min\parallel})$ [-]		2,00	2,00
Gruppenfaktoren unter Querlast bei minimalem Achsabstand in Richtung senkrecht zur Lagerfuge	$\alpha_{g,V\perp}(s_{min\perp}) = \alpha_{g,V\parallel}(s_{min\perp})$ [-]		1,70	1,70

Table C8: Verschiebungen unter Zug- und Querlast

Größe HUS4		8	10
Typ		H(F), C	H(F), C, A(F)
Länge des Dübels im Beton	h_{nom} [mm]	60	75
Zuglast	F_N [kN]	1,9	2,4
Verschiebung unter Zuglast	δ_{N0} [mm]	1,3	0,9
	$\delta_{N\infty}$ [mm]	2,6	1,8
Querlast parallel zu der Stoßfuge	$F_{V\parallel}$ [kN]	2,8	4,0
Verschiebung unter Querlast parallel zu der Stoßfuge ¹⁾	$\delta_{V\parallel 0}$ [mm]	1,7	2,3
	$\delta_{V\parallel \infty}$ [mm]	2,6	3,5
Querlast senkrecht zu der Stoßfuge	$F_{V\perp}$ [kN]	1,5	1,5
Verschiebung unter Querlast senkrecht zu der Stoßfuge ¹⁾	$\delta_{V\perp 0}$ [mm]	1,2	1,2
	$\delta_{V\perp \infty}$ [mm]	1,8	1,8

¹⁾ Die Verschiebung unter Querlast berücksichtigen nicht das Lochspiel und die jeweilige Schraubenposition. Verformungen durch das Lochspiel können durch die Verwendung des Hilti-Verfüllset vermieden werden.

Hilti Betonschraube HUS4

Leistung

Wesentliche Merkmale unter statischer und quasi-statischer Last in Vollziegel

Anhang C4

Table C9: Feuerwiderstand

Größe HUS4				8	10
Typ				H(F), C	H(F), C, A(F)
Länge des Dübels im Beton	h_{nom}	[mm]		60	75
Charakteristischer Widerstand gegen Schrauben-Herausziehen und Steinversagen $N_{RK,fi} = N_{RK,p,fi} = N_{RK,b,fi}$					
Mittlere Druckfestigkeit $f_{mean} \geq 18 \text{ MPa}$	R30, R60, R90	$N_{RK,fi}$	[kN]	0,9	1,2
	R120	$N_{RK,fi}$	[kN]	0,7	0,9
Mittlere Druckfestigkeit $f_{mean} \geq 27 \text{ MPa}$	R30, R60, R90	$N_{RK,fi}$	[kN]	1,1	1,4
	R120	$N_{RK,fi}$	[kN]	0,9	1,1
Charakteristischer Widerstand gegen Steinversagen $N^g_{RK,b,fi}$ für Gruppen von zwei Schrauben					
Mittlere Druckfestigkeit $f_{mean} \geq 18 \text{ MPa}$	R30, R60, R90	$N^g_{RK,b,fi}$	[kN]	2,0	2,3
	R120	$N^g_{RK,b,fi}$	[kN]	1,6	1,8
Mittlere Druckfestigkeit $f_{mean} \geq 27 \text{ MPa}$	R30, R60, R90	$N^g_{RK,b,fi}$	[kN]	2,4	2,7
	R120	$N^g_{RK,b,fi}$	[kN]	1,9	2,2
Rand- und Achsabstände					
Minimaler Randabstand	$c_{min,fi} = c_{j,fi}$	[mm]		120	150
Minimaler Achsabstand	$s_{min,fi}$	[mm]		106	106

Hilti Betonschraube HUS4

Leistung
Wesentliche Merkmale unter Brandbeanspruchung in Vollziegel

Anhang C5

Art des Mauersteins: Kalksandvollstein

Table C10: Beschreibung des Mauersteins

Steintyp		[-]	Vollstein	
Rohdichte	ρ	[kg/dm ³]	$\geq 1,7$	
Mittlere Druckfestigkeit	f_{mean}	[N/mm ²]	≥ 20	
Norm		[-]	EN 771-2:2011	
Steinabmessungen	$l \times b \times h$	[mm]	$\geq 240 \times 115 \times 113$	
Minimale Wanddicke	h_{min}	[mm]	≥ 115	

Table C11: Installationsparameter

Größe HUS4 Typ			8 H(F), C	10 H(F), C, A(F)	
Installationsparameter					
Länge des Dübels im Beton		h_{nom}	[mm]	60	75
Setzwerkzeug: Bohrschrauber und Leistungsbegrenzung			[-]	Darf nicht verwendet werden	
Setzwerkzeug: Schlagschrauber und Leistungsbegrenzung	Typ und Leistungsbegrenzung		[-]	SIW 4AT-22 Gear 1	SIW 4AT-22 Gear 1
	Maximale Drehmoment gemäß Herstellerangabe		[Nm]	90	90
Rand- und Achsabstände					
Minimaler Randabstand zum freien Rand		c_{min}	[mm]	$1,5 h_{\text{nom}}$	
Minimaler Achsabstand		$s_{\text{min}} \parallel = s_{\text{min}} \perp$	[mm]	80	
Charakteristischer Randabstand		c_{cr}	[mm]	$1,5 h_{\text{nom}}$	
Charakteristischer Achsabstand		s_{cr}	[mm]	$3,0 h_{\text{nom}}$	

¹⁾ Installation mit anderem Schlagschrauber bei gleichwertiger Leistung ist zulässig.

Hilti Betonschraube HUS4

Leistung

Wesentliche Merkmale unter statischer und quasi-statischer Last in Kalksandvollstein

Anhang C6

Table C12: Charakteristischer Widerstand unter Zug- und Querbeanspruchung

Größe HUS4 Typ	8 H(F), C		10 H(F), C, A(F)	
	trocken	nass	trocken	nass
Nutzungskategorie				
Länge des Dübels im Beton h_{nom} [mm]	60		75	
Charakteristischer Widerstand eines einzelnen Schraubankers gegen Herausziehen oder Ausbruch des Mauersteins unter Zug- und Querbeanspruchung				
Mittlere Steindruckfestigkeit f_{mean} [MPa]	$N_{RK} = N_{RK,b} = N_{RK,p} = N_{RK,b,c} = N_{RK,p,c}$ [kN]			
≥ 20	9,4		9,9	9,4
≥ 30	11,3		12,0	11,3
Charakteristischer Widerstand eines einzelnen Schraubankers gegen örtliches Versagen oder Kantenbruch des Mauersteins unter Querbeanspruchung				
Mittlere Steindruckfestigkeit f_{mean} [MPa]	$V_{RK,\parallel} = V_{RK,b,\parallel} = V_{RK,c,\parallel}$ [kN]			
≥ 20	13,6		15,6	
≥ 30	16,4		18,8	
Mittlere Steindruckfestigkeit f_{mean} [MPa]	$V_{RK,\perp} = V_{RK,b,\perp} = V_{RK,c,\perp}$ [kN]			
≥ 20	3,5		3,5	
≥ 30	4,3		4,3	

Table C13: Abminderung in Abhängigkeit vom Fugenabstand

Größe HUS4 Typ	8 H(F), C		10 H(F), C, A(F)	
	Länge des Dübels im Beton h_{nom} [mm]	60		75
Maximale Fugenbreite w_j [mm]	≤ 10		≤ 10	
Abstand zu Fugen c_j [mm]	c_j^\perp	$\geq 41,5$	$\geq 41,5$	
	c_j^\parallel	$\geq 1,5 h_{mon}$	$\geq 1,5 h_{mon}$	
Abminderungsfaktor α_j [-]	$\alpha_{j,N}$	1,0	1,0	
	α_{j,V^\parallel}	1,0	1,0	
	α_{j,V^\perp}	1,0	1,0	
Abstand zu Fugen c_j [mm]	c_j^\perp	≥ 20	≥ 20	
	c_j^\parallel	≥ 40	≥ 40	
Abminderungsfaktor α_j [-]	$\alpha_{j,N}$	0,78	0,87	
	α_{j,V^\parallel}	1,0	1,0	
	α_{j,V^\perp}	1,0	1,0	
Abstand zu Fugen c_j [mm]	c_j^\perp	< 20	< 20	
	c_j^\parallel	< 40	< 40	
Abminderungsfaktor α_j [-]	$\alpha_{j,N}$ α_{j,V^\parallel} α_{j,V^\perp}	Die Schraube darf nicht verwendet werden		

Hilti Betonschraube HUS4

Leistung

Wesentliche Merkmale unter statischer und quasi-statischer Last in Kalksandvollstein

Anhang C7

Table C14: Gruppenfaktoren für Gruppen von zwei Ankern



Größe HUS4				Anwendung		8	10
Typ						H(F), C	H(F), C, A(F)
Minimale Achsabstand	$s_{min\parallel} = s_{min\perp}$	[mm]		-		80	80
Gruppenfaktoren unter Zuglast	$\alpha_{g,N}(s_{min\parallel}) = \alpha_{g,N}(s_{min\perp})$		[-]			1,45	1,80
Gruppenfaktoren unter Querlast bei minimalem Achsabstand in Richtung parallel zur Lagerfuge	$\alpha_{g,V\perp}(s_{min\parallel}) = \alpha_{g,V\parallel}(s_{min\parallel})$		[-]			1,70	1,70
Gruppenfaktoren unter Querlast bei minimalem Achsabstand in Richtung senkrecht zur Lagerfuge	$\alpha_{g,V\perp}(s_{min\perp}) = \alpha_{g,V\parallel}(s_{min\perp})$		[-]			1,45	1,45

Table C15: Verschiebungen unter Zug- und Querlast

Größe HUS4				8	10
Typ				H(F), C	H(F), C, A(F)
Länge des Dübels im Beton	h_{nom}	[mm]		60	75
Zuglast	F_N	[kN]		3,2	3,4
Verschiebung unter Zuglast	δ_{N0}	[mm]		0,4	0,4
	$\delta_{N\infty}$			0,8	0,8
Querlast parallel zu der Stoßfuge	$F_{V\parallel}$	[kN]		4,7	5,4
Verschiebung unter Querlast parallel zu der Stoßfuge ¹⁾	$\delta_{V\parallel 0}$	[mm]		1,7	1,7
	$\delta_{V\parallel \infty}$			2,6	2,6
Querlast senkrecht zu der Stoßfuge	$F_{V\perp}$	[kN]		1,2	1,2
Verschiebung unter Querlast senkrecht zu der Stoßfuge ¹⁾	$\delta_{V\perp 0}$	[mm]		0,7	0,7
	$\delta_{V\perp \infty}$			1,1	1,1

¹⁾ Die Verschiebung unter Querlast berücksichtigen nicht das Lochspiel und die jeweilige Schraubenposition. Verformungen durch das Lochspiel können durch die Verwendung des Hilti-Verfüllset vermieden werden.

Hilti Betonschraube HUS4

Leistung

Wesentliche Merkmale unter statischer und quasi-statischer Last in Kalksandvollstein

Anhang C8

Table C16: Feuerwiderstand

Größe HUS4				8	10
Typ				H(F), C	H(F), C, A(F)
Länge des Dübels im Beton	h_{nom}	[mm]		60	75
Charakteristischer Widerstand gegen Schrauben-Herausziehen und Steinversagen $N_{RK,fi} = N_{RK,p,fi} = N_{RK,b,fi}$					
Mittlere Druckfestigkeit $f_{mean} \geq 20 \text{ MPa}$	R30, R60, R90	$N_{RK,fi}$	[kN]	1,6	1,7
	R120	$N_{RK,fi}$	[kN]	1,3	1,3
Mittlere Druckfestigkeit $f_{mean} \geq 30 \text{ MPa}$	R30, R60, R90	$N_{RK,fi}$	[kN]	1,9	2,1
	R120	$N_{RK,fi}$	[kN]	1,5	1,6
Charakteristischer Widerstand gegen Steinversagen $N^g_{RK,b,fi}$ für Gruppen von zwei Schrauben					
Mittlere Druckfestigkeit $f_{mean} \geq 20 \text{ MPa}$	R30, R60, R90	$N^g_{RK,b,fi}$	[kN]	2,8	4,6
	R120	$N^g_{RK,b,fi}$	[kN]	2,2	3,7
Mittlere Druckfestigkeit $f_{mean} \geq 30 \text{ MPa}$	R30, R60, R90	$N^g_{RK,b,fi}$	[kN]	3,4	5,6
	R120	$N^g_{RK,b,fi}$	[kN]	2,7	4,5
Rand- und Achsabstände					
Minimaler Randabstand	$c_{min,fi} = c_{j,fi}$	[mm]		120	150
Minimaler Achsabstand	$s_{min,fi}$	[mm]		106	106

Hilti Betonschraube HUS4

Leistung

Wesentliche Merkmale unter Brandbeanspruchung in Kalksandvollstein

Anhang C9

Brick type: Leichtbetonvollstein

Table C17: Beschreibung des Mauersteins

Steintyp		[-]	Vollstein	
Rohdichte	ρ	[kg/dm ³]	≥ 0,9	
Druckfestigkeit	f_{mean}	[N/mm ²]	≥ 5	
Norm		[-]	EN 771-3:2011	
Steinabmessungen	$l \times b \times h$	[mm]	≥ 498 x 150 x 199	
Minimale Wanddicke	h_{min}	[mm]	≥ 150	

Table C18: Installationsparameter

Größe HUS4 Typ			8 H(F), C	10 H(F), C, A(F)
Installationsparameter				
Länge des Dübels im Beton	h_{nom}	[mm]	60	75
Setzwerkzeug: Bohrschrauber und Leistungsbegrenzung		[-]	SF 6H-A22 Gear 2 / 10	SF 6H-A22 Gear 2 / 15
Setzwerkzeug: Schlagschrauber und Leistungsbegrenzung	Typ und Leistungsbegrenzung Maximale Drehmoment gemäß Herstellerangabe	[-] [Nm]	Darf nicht verwendet werden	
Rand- und Achsabstände				
Minimaler Randabstand zum freien Rand	c_{min}	[mm]	1,5 h_{nom}	
Minimaler Achsabstand	$s_{\text{min}} \parallel = s_{\text{min}}^{\perp}$	[mm]	80	
Charakteristischer Randabstand	c_{cr}	[mm]	1,5 h_{nom}	
charakteristischer Achsabstand	s_{cr}	[mm]	3,0 h_{nom}	

Hilti Betonschraube HUS4

Leistung

Wesentliche Merkmale unter statischer und quasi-statischer Last in Leichtbetonvollstein

Anhang C10

Table C19: Charakteristischer Widerstand unter Zug- und Querbeanspruchung

Größe HUS4 Typ	8 H(F), C		10 H(F), C, A(F)	
	trocken	nass	trocken	nass
Nutzungskategorie				
Länge des Dübels im Beton h_{nom} [mm]	60		75	
Charakteristischer Widerstand eines einzelnen Schraubankers gegen Herausziehen oder Ausbruch des Mauersteins unter Zug- und Querbeanspruchung				
Mittlere Steindruckfestigkeit f_{mean} [MPa]	$N_{RK} = N_{RK,b} = N_{RK,p} = N_{RK,b,c} = N_{RK,p,c}$ [kN]			
$\geq 5,0$	2,8		3,5	
$\geq 7,5$	3,5		4,5	
Charakteristischer Widerstand eines einzelnen Schraubankers gegen örtliches Versagen oder Kantenbruch des Mauersteins unter Querbeanspruchung				
Mittlere Steindruckfestigkeit f_{mean} [MPa]	$V_{RK,\parallel} = V_{RK,b,\parallel} = V_{RK,c,\parallel}$ [kN]			
$\geq 5,0$	1,8		4,2	
$\geq 7,5$	2,1		5,2	
Mittlere Steindruckfestigkeit f_{mean} [MPa]	$V_{RK,\perp} = V_{RK,b,\perp} = V_{RK,c,\perp}$ [kN]			
$\geq 5,0$	1,3		1,6	
$\geq 7,5$	1,6		1,9	

Table C20: Abminderung in Abhängigkeit vom Fugenabstand

Größe HUS4 Typ	8 H(F), C		10 H(F), C, A(F)	
	Länge des Dübels im Beton h_{nom} [mm]	60		75
Maximale Fugenbreite w_j [mm]	≤ 10		≤ 10	
Abstand zu Fugen $c_{j,\perp}$ [mm]	$\geq 1,5 h_{nom}$		≥ 99	
	$c_{j,\parallel}$ [mm]		$\geq 1,5 h_{nom}$	
Abminderungsfaktor $\alpha_{j,N}$ [-]	1,0		1,0	
	$\alpha_{j,V\parallel}$ [-]		1,0	
	$\alpha_{j,V\perp}$ [-]		1,0	
Abstand zu Fugen $c_{j,\perp}$ [mm]	≥ 20		≥ 20	
	$c_{j,\parallel}$ [mm]		≥ 40	
Abminderungsfaktor $\alpha_{j,N}$ [-]	0,76		0,59	
	$\alpha_{j,V\parallel}$ [-]		1,00	
	$\alpha_{j,V\perp}$ [-]		0,60	
Abstand zu Fugen $c_{j,\perp}$ [mm]	< 20		< 20	
	$c_{j,\parallel}$ [mm]		< 40	
Abminderungsfaktor $\alpha_{j,N}$ [-]	Die Schraube darf nicht verwendet werden			

Hilti Betonschraube HUS4

Leistung

Wesentliche Merkmale unter statischer und quasi-statischer Last in Leichtbetonvollstein

Anhang C11

Table C21: Gruppenfaktoren für Gruppen von zwei Ankern



Größe HUS4				8	10
Typ			Anwendung	H(F), C	H(F), C, A(F)
Minimale Achsabstand	$s_{min\parallel} = s_{min\perp}$	[mm]	-	80	80
Gruppenfaktoren unter Zuglast	$\alpha_{g,N}(s_{min\parallel}) = \alpha_{g,N}(s_{min\perp})$	[-]		2,00	1,60
Gruppenfaktoren unter Querlast bei minimalem Achsabstand in Richtung parallel zur Lagerfuge	$\alpha_{g,V\perp}(s_{min\parallel}) = \alpha_{g,V\parallel}(s_{min\parallel})$	[-]		1,60	1,60
Gruppenfaktoren unter Querlast bei minimalem Achsabstand in Richtung senkrecht zur Lagerfuge	$\alpha_{g,V\perp}(s_{min\perp}) = \alpha_{g,V\parallel}(s_{min\perp})$	[-]		2,00	2,00

Table C22: Verschiebungen unter Zug- und Querlast

Größe HUS4				8	10
Typ				H(F), C	H(F), C, A(F)
Länge des Dübels im Beton	h_{nom}	[mm]		60	75
Zuglast	F_N	[kN]		0,8	1,0
Verschiebung unter Zuglast	δ_{N0} $\delta_{N\infty}$	[mm]		0,05	0,10
				0,10	0,20
Querlast parallel zu der Stoßfuge	$F_{V\parallel}$	[kN]		0,6	1,5
Verschiebung unter Querlast parallel zu der Stoßfuge ¹⁾	$\delta_{V\parallel 0}$ $\delta_{V\parallel \infty}$	[mm]		0,50	0,70
				0,75	1,10
Querlast senkrecht zu der Stoßfuge	$F_{V\perp}$	[kN]		0,5	0,5
Verschiebung unter Querlast senkrecht zu der Stoßfuge ¹⁾	$\delta_{V\perp 0}$ $\delta_{V\perp \infty}$	[mm]		0,70	0,60
				1,10	0,90

¹⁾ Die Verschiebung unter Querlast berücksichtigen nicht das Lochspiel und die jeweilige Schraubenposition. Verformungen durch das Lochspiel können durch die Verwendung des Hilti-Verfüllset vermieden werden.

Hilti Betonschraube HUS4

Leistung

Wesentliche Merkmale unter statischer und quasi-statischer Last in Leichtbetonvollstein

Anhang C12

Table C23: Feuerwiderstand

Größe HUS4				8	10
Typ				H(F), C	H(F), C, A(F)
Länge des Dübels im Beton		h_{nom}	[mm]	60	75
Charakteristischer Widerstand unter Brandbeanspruchung gegen Schrauben-Herausziehen und Steinversagen $N_{Rk,fi} = N_{Rk,p,fi} = N_{Rk,b,fi}$ von einzeln Schraube					
Mittlere Druckfestigkeit $f_{mean} \geq 5 \text{ MPa}$	R30, R60, R90	$N_{Rk,fi}$	[kN]	0,4	0,4
	R120	$N_{Rk,fi}$	[kN]	0,3	0,3
Mittlere Druckfestigkeit $f_{mean} \geq 7,5 \text{ MPa}$	R30, R60, R90	$N_{Rk,fi}$	[kN]	0,4	0,6
	R120	$N_{Rk,fi}$	[kN]	0,3	0,4
Charakteristischer Widerstand unter Brandbeanspruchung gegen Steinversagen $N_{Rk,b,fi}^g$ für Gruppen von zwei Schrauben					
Mittlere Druckfestigkeit $f_{mean} \geq 5 \text{ MPa}$	R30, R60, R90	$N_{Rk,b,fi}^g$	[kN]	0,9	1,1
	R120	$N_{Rk,b,fi}^g$	[kN]	0,7	0,9
Mittlere Druckfestigkeit $f_{mean} \geq 7,5 \text{ MPa}$	R30, R60, R90	$N_{Rk,b,fi}^g$	[kN]	1,1	1,4
	R120	$N_{Rk,b,fi}^g$	[kN]	0,9	1,1
Rand- und Achsabstände					
Minimaler Randabstand		$c_{min,fi} = c_{j,fi}$	[mm]	120	150
Minimaler Achsabstand		$s_{min,fi}$	[mm]	106	106

Hilti Betonschraube HUS4

Leistung

Wesentliche Merkmale unter Brandbeanspruchung in Leichtbetonvollstein

Anhang C13

Brick type: Porenbetonstein

Table C24: Beschreibung des Mauersteins

Steintyp		[-]	Vollstein	
Rohdichte	ρ	[kg/dm ³]	≥ 0,55	
Druckfestigkeit	f_{mean}	[N/mm ²]	≥ 4	
Norm		[-]	EN 771-4:2011	
Steinabmessungen	$l \times b \times h$	[mm]	≥ 499 x 240 x 249	
Minimale Wanddicke	h_{min}	[mm]	≥ 240	

Table C25: Installationsparameter

Größe HUS4 Typ			8 H(F), C	10 H(F), C, A(F)
Installationsparameter				
Länge des Dübels im Beton	h_{nom}	[mm]	60	75
Installation torque	T_{inst}	[Nm]	-	-
Setzwerkzeug: Bohrschrauber und Leistungsbegrenzung		[-]	SF 6H-A22 Gear 2 / 10	SF 6H-A22 Gear 2 / 15
Setzwerkzeug: Schlagschrauber und Leistungsbegrenzung	Typ und Leistungsbegrenzung Maximale Drehmoment gemäß Herstellerangabe	[-] [Nm]	Darf nicht verwendet werden	
Rand- und Achsabstände				
Minimaler Randabstand zum freien Rand	c_{min}	[mm]	1,5 h_{nom}	
Minimaler Achsabstand	$s_{min} \parallel = s_{min} \perp$	[mm]	80	
Charakteristischer Randabstand	c_{cr}	[mm]	1,5 h_{nom}	
charakteristischer Achsabstand	s_{cr}	[mm]	3,0 h_{nom}	

¹⁾ Installation mit anderem Schlagschrauber oder Bohrschrauber bei gleichwertiger Leistung ist zulässig.

Hilti Betonschraube HUS4

Leistung

Wesentliche Merkmale unter statischer und quasi-statischer Last in Porenbetonstein

Anhang C14

Table C26: Charakteristischer Widerstand unter Zug- und Querbeanspruchung

Größe HUS4	8		10	
Typ	H(F), C		H(F), C, A(F)	
Nutzungskategorie	trocken	nass	trocken	nass
Länge des Dübels im Beton h_{nom} [mm]	60		75	
Charakteristischer Widerstand eines einzelnen Schraubankers gegen Herausziehen oder Ausbruch des Mauersteins unter Zug- und Querbeanspruchung				
Mittlere Steindruckfestigkeit f_{mean} [MPa] / Rohdichte [kg/m ³]	$N_{RK} = N_{RK,b} = N_{RK,p} = N_{RK,b,c} = N_{RK,p,c}$ [kN]			
≥ 4 / 550	0,5		0,8	
≥ 6 / 650	0,9		1,4	
Charakteristischer Widerstand eines einzelnen Schraubankers gegen örtliches Versagen oder Kantenbruch des Mauersteins unter Querbeanspruchung				
Mittlere Steindruckfestigkeit f_{mean} [MPa] / Rohdichte [kg/m ³]	$V_{RK, } = V_{RK,b, } = V_{RK,c, }$ [kN]			
≥ 4 / 550	1		1,6	
≥ 6 / 650	1,8		2,8	
Mittlere Steindruckfestigkeit f_{mean} [MPa] / Rohdichte [kg/m ³]	$V_{RK,\perp} = V_{RK,b,\perp} = V_{RK,c,\perp}$ [kN]			
≥ 4 / 550	0,3		0,4	
≥ 6 / 650	0,5		0,7	

Table C27: Abminderung in Abhängigkeit vom Fugenabstand

Größe HUS4	8		10	
Typ	H(F), C		H(F), C, A(F)	
Länge des Dübels im Beton h_{nom} [mm]	60		75	
Maximale Fugenbreite w_j [mm]	≤ 3		≤ 3	
Abstand zu Fugen $c_{j,\perp}$ [mm]	≥ 1,5 h_{nom}		≥ 1,5 h_{nom}	
	$c_{j, }$ [mm]		≥ 1,5 h_{nom}	
Abminderungsfaktor $\alpha_{j,N}$ [-]	1,0		1,0	
	$\alpha_{j,V, }$		1,0	
	$\alpha_{j,V,\perp}$		1,0	
Abstand zu Fugen $c_{j,\perp}$ [mm]	≥ 20		≥ 20	
	$c_{j, }$ [mm]		≥ 40	
Abminderungsfaktor $\alpha_{j,N}$ [-]	0,73		0,96	
	$\alpha_{j,V}$		1,0	
	$\alpha_{j,V,\perp}$		0,45	
Abstand zu Fugen $c_{j,\perp}$ [mm]	< 20		< 20	
	$c_{j, }$ [mm]		< 40	
Abminderungsfaktor $\alpha_{j,N}$ [-]	Die Schraube darf nicht verwendet werden			
	$\alpha_{j,V, }$			
	$\alpha_{j,V,\perp}$			

Hilti Betonschraube HUS4

Leistung

Wesentliche Merkmale unter statischer und quasi-statischer Last in Leichtbetonvollstein

Anhang C15

Table C28: Gruppenfaktoren für Gruppen von zwei Ankern



Größe HUS4				Anwendung		8	10
Typ						H(F), C	H(F), C, A(F)
Minimale Achsabstand	$s_{\min\parallel} = s_{\min\perp}$	[mm]		-		80	80
Gruppenfaktoren unter Zuglast	$\alpha_{g,N}(s_{\min\parallel}) = \alpha_{g,N}(s_{\min\perp})$		[-]			1,85	2,00
Gruppenfaktoren unter Querlast bei minimalem Achsabstand in Richtung parallel zur Lagerfuge	$\alpha_{g,V\perp}(s_{\min\parallel}) = \alpha_{g,V\parallel}(s_{\min\parallel})$		[-]			2,00	2,00
Gruppenfaktoren unter Querlast bei minimalem Achsabstand in Richtung senkrecht zur Lagerfuge	$\alpha_{g,V\perp}(s_{\min\perp}) = \alpha_{g,V\parallel}(s_{\min\perp})$		[-]			1,25	1,00

Table C29: Verschiebungen unter Zug- und Querlast

Größe HUS4				8	10
Typ				H(F), C	H(F), C, A(F)
Länge des Dübels im Beton	h_{nom}	[mm]		60	75
Zuglast	F_N	[kN]		0,3	0,5
Verschiebung unter Zuglast	δ_{N0}	[mm]		0,02	0,03
	$\delta_{N\infty}$			0,04	0,06
Querlast parallel zu der Stoßfuge	$F_{V\parallel}$	[kN]		0,6	1,0
Verschiebung unter Querlast parallel zu der Stoßfuge ¹⁾	$\delta_{V\parallel 0}$	[mm]		1,20	1,20
	$\delta_{V\parallel \infty}$			1,80	1,80
Querlast senkrecht zu der Stoßfuge	$F_{V\perp}$	[kN]		0,2	0,3
Verschiebung unter Querlast senkrecht zu der Stoßfuge ¹⁾	$\delta_{V\perp 0}$	[mm]		0,30	0,80
	$\delta_{V\perp \infty}$			0,45	1,20

¹⁾ Die Verschiebung unter Querlast berücksichtigen nicht das Lochspiel und die jeweilige Schraubenposition. Verformungen durch das Lochspiel können durch die Verwendung des Hilti-Verfüllset vermieden werden.

Hilti Betonschraube HUS4

Leistung

Wesentliche Merkmale unter statischer und quasi-statischer Last in Leichtbetonvollstein

Anhang C16

Table C30: Feuerwiderstand

Größe HUS4				8	10
Typ				H(F), C	H(F), C, A(F)
Länge des Dübels im Beton		h_{nom}	[mm]	60	75
Charakteristischer Widerstand unter Brandbeanspruchung gegen Schrauben-Herausziehen und Steinversagen $N_{Rk,fi} = N_{Rk,p,fi} = N_{Rk,b,fi}$ von einzeln Schraube					
Mittlere Druckfestigkeit $f_{mean} \geq 4$ MPa ($\rho \geq 0,55$ kg/dm ³)	R30, R60, R90	$N_{Rk,fi}$	[kN]	Leistung nicht bewertet	0,1
	R120	$N_{Rk,fi}$	[kN]		0,1
Mittlere Druckfestigkeit $f_{mean} \geq 6$ MPa ($\rho \geq 0,65$ kg/dm ³)	R30, R60, R90	$N_{Rk,fi}$	[kN]	0,1	0,2
	R120	$N_{Rk,fi}$	[kN]	0,1	0,2
Charakteristischer Widerstand unter Brandbeanspruchung gegen Steinversagen $N_{Rk,b,fi}^g$ für Gruppen von zwei Schrauben					
Mittlere Druckfestigkeit $f_{mean} \geq 4$ MPa ($\rho \geq 0,55$ kg/dm ³)	R30, R60, R90	$N_{Rk,b,fi}^g$	[kN]	Leistung nicht bewertet	0,4
	R120	$N_{Rk,b,fi}^g$	[kN]		0,3
Mittlere Druckfestigkeit $f_{mean} \geq 6$ MPa ($\rho \geq 0,65$ kg/dm ³)	R30, R60, R90	$N_{Rk,b,fi}^g$	[kN]	0,3	0,7
	R120	$N_{Rk,b,fi}^g$	[kN]	0,2	0,5
Rand- und Achsabstände					
Minimaler Randabstand		$c_{min,fi} = c_{j,fi}$	[mm]	120	150
Minimaler Achsabstand		$s_{min,fi}$	[mm]	106	106

Hilti Betonschraube HUS4

Leistung

Wesentliche Merkmale unter Brandbeanspruchung in Leichtbetonvollstein

Anhang C17