



# Connection of timber structures to concrete with steel elements

Using post-installed anchoring systems





# Table of Contents

|  |           |
|--|-----------|
| <b>Foreword</b>  | <b>5</b>  |
| <b>1. Introduction</b>   | <b>6</b>  |
| <b>2. Timber to concrete applications</b>                                    | <b>8</b>  |
| 2.1 Timber wall to concrete connections                                      | 9         |
| 2.2 Timber column to concrete connections                                    | 11        |
| 2.3 Timber beam to concrete connections                                      | 13        |
| 2.4 Timber panel to concrete support or wall                                 | 15        |
| <b>3. Post-installed anchors</b>   | <b>16</b> |
| 3.1 Post-installed mechanical and bonded anchors                             | 16        |
| 3.1.1 Mechanical anchors   | 17        |
| 3.1.2 Bonded anchors   | 18        |
| 3.2 Failure modes and main influencing factors                               | 18        |
| 3.2.1 Failure modes under tensile loads                                      | 18        |
| 3.2.2 Failure modes under shear loads  | 19        |
| 3.2.3 Other factors influencing the anchor performance                       | 20        |
| 3.3 Qualification and design of post-installed anchors                       | 21        |
| 3.4 PROFIS Engineering: a powerful software for efficient design             | 22        |
| 3.5 Typical Hilti post-installed anchors for Timber to concrete applications | 23        |
| <b>4. Technical data/Properties of main Hilti post-installed anchors</b>     | <b>25</b> |
| 4.1 Hilti HST4 (-R) Expansion anchor   | 26        |
| 4.1.1 Minimum concrete slab thickness, edge distance and spacing             | 27        |
| 4.1.2 Static, quasi-static and seismic C2 anchor design resistance           | 29        |
| 4.2 Hilti HST2 V3 Expansion anchor   | 31        |
| 4.2.1 Minimum concrete slab thickness, edge distance and spacing             | 32        |
| 4.2.2 Static, quasi-static and seismic C2 anchor design resistance           | 34        |
| 4.3 Hilti HUS4 Screw anchor for use in concrete                              | 35        |
| 4.3.1 Minimum concrete slab thickness, edge distance and spacing             | 36        |
| 4.3.2 Static, quasi-static and seismic C1 anchor design resistance           | 37        |
| 4.4 Hilti HIT-HY200-A V3 and -R V3 injection mortars with HAS U rods         | 38        |
| 4.4.1 Minimum concrete slab thickness, edge distance and spacing             | 40        |
| 4.4.2 Static, quasi-static and seismic C2 anchor design resistance           | 41        |
| 4.5 Hilti HVU2 adhesive capsule with HAS U rods                              | 42        |
| 4.5.1 Minimum concrete slab thickness, edge distance and spacing             | 43        |

|                        |   |           |
|------------------------|---|-----------|
| 4.5.2                  | Static, quasi-static and seismic C2 anchor design resistance  | 44        |
| <b>5.</b>              | <b>Design examples</b>  | <b>45</b> |
| <b>5.1</b>             | A checklist before starting to design post-installed anchors  | <b>47</b> |
| <b>5.2</b>             | Design using Hilti's PROFIS Engineering   | <b>48</b> |
| <b>5.3</b>             | Example #1: Connection between timber wall and concrete foundation with holdowns and bonded anchors | <b>50</b> |
| 5.3.1                  | Brief description of the application  | 50        |
| 5.3.2                  | Summary of relevant project information   | 51        |
| 5.3.3                  | Selected post-installed anchor and installation conditions  | 51        |
| 5.3.4                  | Resulting anchor forces   | 51        |
| 5.3.5                  | Design verification for failure modes against tension loads   | 52        |
| 5.3.6                  | Alternative Hilti anchors suitable for the application  | 54        |
| <b>5.4</b>             | Example #2: Connection between timber panel and concrete slab with angle bracket and screw anchors  | <b>55</b> |
| 5.4.1                  | Brief description of the application  | 55        |
| 5.4.2                  | Summary of relevant project information   | 55        |
| 5.4.3                  | Selected post-installed anchor  | 56        |
| 5.4.4                  | Resulting anchor forces   | 56        |
| 5.4.5                  | Design verification for failure modes against tension loads   | 56        |
| 5.4.6                  | Design verification for failure modes against shear loads   | 59        |
| 5.4.7                  | Design verification for combined tension and shear loads  | 61        |
| 5.4.8                  | Alternative Hilti anchors suitable for the application  | 62        |
| <b>6.</b>              | <b>Conclusion</b>   | <b>63</b> |
| <b>7.</b>              | <b>Reference projects</b>   | <b>64</b> |
| 7.1                    | Headquarters Umweltbank Nuremberg, Germany  | 64        |
| <b>Acknowledgments</b> |   | <b>66</b> |
| <b>References</b>      |   | <b>67</b> |

## Foreword

by

**Dr. Lars Taenzer**

**BU Head, Anchors**

**Hilti Corporation**



In today's rapidly advancing world, staying up to date with the developments in the construction industry is essential. Among other benefits, timber offers substantial environmental benefits to the construction industry as a renewable resource with a lower carbon footprint than more conventional materials like concrete and steel. As such, the development of timber to concrete connections has been a significant focus in most recent years, as the demand for hybrid structures combining the sustainability and flexibility of timber with the strength and durability of concrete continues to grow particularly in mid-rise and high-rise buildings. The evolution of these connections has been driven by advancements in materials, engineering practices and construction technologies.

This handbook provides an overview of timber to concrete standard applications such as connections between structural elements such as timber columns, beams and walls, to concrete core elements of the structure (e.g. foundation, or load-bearing walls). In such applications different types of steel elements are usually involved that are typically screwed or doweled to the timber members and connected to concrete via post-installed anchors. The design and use of suitable post-installed anchors depends on load requirements, environmental conditions, and installation methods, which must be considered for each specific case.

The handbook covers a broad range of topics from fundamental mechanical principles of post-installed anchors to applications requirement and main characteristics. It further presents a suitable selection of potential solutions among the current Hilti portfolio, including their key features, required approvals and qualifications, as well as design principles according to European standards, considering also relevant design examples completed with PROFIS Engineering software.

The handbook constitutes an important reference resource for structural designers and other construction professionals who are either less familiar with post-installed anchors or simply want to catch up on the state-of-the-art products in the field. It provides a solid foundation and explores emerging trends helping to be prepared for challenges and opportunities ahead. It is an honor to introduce this book, and I am confident that it will become an indispensable resource for those who are new to the world of timber-to-concrete connections, as well as for contractors, in-house technical teams and others who are directly or indirectly associated with such applications.

# 1. Introduction

Timber-to-concrete fastening is a crucial component in timber buildings, as it enables the integration of the two materials to enhance the performance of the overall structure. Being critical for the load transfer within the various structural elements, the design and execution of timber-to-concrete fastening must adhere to rigorous quality and safety norms. A variety of solutions and technologies for timber-to-concrete fastening are available in the market. These range from more traditional solutions, such as steel brackets, shear plates and steel footpads, to more innovative bespoke solutions that are usually integrated in the manufacturing process, such as the Hilti Coupler Wood used to connect two timber elements or a timber element to a concrete member and transfer both tension and/or shear loads from the timber member via the coupler and anchor to the base material.

Among different employed methods, post-installed anchors are one of the most common technologies used to fasten timber members to concrete structural elements, such as foundations, columns, slabs or walls. Connections may be realized with or without the aid of other steel elements such as angle brackets, shear plates, knife plates, etc. While the steel elements are usually screwed or doweled to the timber members, they are connected to concrete via post-installed anchors. From a technological point of view, post-installed anchors can be classified into two main categories: mechanical anchors, which rely on friction and mechanical interlock to transfer the loads to the base material; and bonded anchors, which utilize adhesive materials such as epoxy resins to help secure the anchor into place. Each type offers different benefits and limitations and may be more suited to certain applications and/or jobsite conditions.

The design of post-installed anchors depends on several factors, including anchor technology and size, concrete properties and quality, connector geometry (e.g., bracket size), load magnitude and direction, and edge and spacing distances, among others. All these parameters influence, with varying degrees of importance, the anchors' utilization and failure modes. Therefore, the selection and design of post-installed anchors must follow relevant codes and standards, as well as best practices and recommendations from manufacturers and experts. The European design standard EN 1992-4 [2] provides a comprehensive design methodology for anchors. It applies to both mechanical and bonded anchors for varied loading conditions, including static, seismic and fire-induced loads.

The objective of this handbook is to provide guidance for selecting and designing post-installed anchors for timber-to-concrete fastening applications (Fig. 1.1), complete with design examples and detailed calculations. The handbook primarily supports structural engineers in the timber construction business, who aim to refine their expertise in anchor technology. It is also useful for contractors or other related professionals who commonly deal with this type of application. It covers following topics:

- An outline of typical applications for timber-to-concrete connections, including columns, beams, walls, floor and roof systems, further indicating relevant Hilti solutions for each application ([Chapter 2](#) and [4](#)).
- A brief overview of post-installed anchors, their working principles and design according to EN 1992-4 [2] ([Chapter 3](#))
- Illustrative design scenarios, delineating the relevant steps in the design process for anchors, supported by the necessary design calculations according to the EN 1992-4 [2], as implemented in Hilti PROFIS Engineering software ([Chapter 5](#)).

We hope that this handbook will successfully support you in the selection and design of timber-to-concrete fastening systems for your construction projects. We further invite you to contact our team of experts for any technical consultation or assistance you might require along the way.

**Note:** See Hilti HCW whitepaper [1] for more details.





Fig. 1.1: Timber construction site

## 2. Timber to concrete applications

One of the main challenges in timber construction is the connection of timber elements to concrete foundations, or to the rest of the concrete sub-structure in hybrid buildings. Prefabricated or cast-in solutions are not always possible, leaving post-installed solutions as the only viable choice. For instance, these may be needed when there are mismatches in height at the interface between the concrete and the timber elements. Typical timber-concrete building construction site is shown in Fig. 2.1. Post-installed fastening solutions usually entail the use of metal plates, supports or brackets (Fig. 2.2) that are screwed to the timber elements on one side and fastened to concrete on the other. Such methods offer, in general, higher flexibility for positioning and easier inspection, although they may be less appealing from an aesthetic perspective. They can also present additional challenges during installation, for example in areas with dense reinforcement. Further details on post-installed anchors, i.e., working principles, failure modes, qualification framework etc. are discussed in [Chapter 3](#). Additional fastening solutions include driving anchors through the timber element (Fig. 2.3), such as for beam fastening on walls or connecting bottom plates of light timber frames to concrete foundations.

The connection of a steel bracket (or other metal connectors) to a timber component is often realized with mechanical fasteners, such as timber screws or nails. The performance of the connection depends on several parameters. For example, the mechanical properties of the timber, the number, quality and mechanical properties of the fasteners, the distance between fasteners and edges of the timber element, among other factors, can all have an impact on the overall connector performance. The most common fasteners for timber-to-steel connections are nails, screws, bolts and dowels (made of steel or wood), with bonded rods used for stronger connections. The design of the connection should also consider a range of additional requirements from geometry and aesthetics to environmental factors (moisture, durability), fire resistance, cost, installation, compatibility of materials and approvals for use under specific load conditions (e.g. seismic loads). Manufacturers of these connectors, as well as international codes and standards such as EN 1995-1 [3], provide detailed information on the design of the timber-to-metal connection and the relevant fastening solution. However, it is often the case that less guidance is provided with regards to fastening of the connector to concrete.

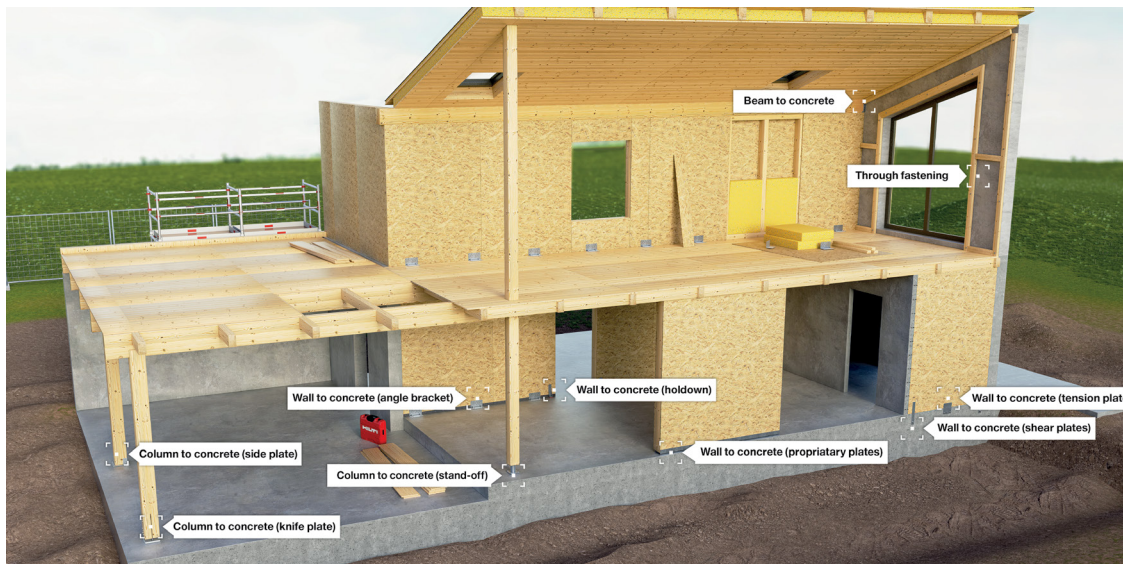

Fig. 2.1: Timber building construction site



This chapter does not cover all potential timber-to-concrete connections (which are numerous and ever-evolving, due to continuous technological advancement), but collects representative examples of applications where post-installed anchors are typically used.



**Fig. 2.2: Setting of a concrete screw anchor to fasten a timber frame wall element to concrete via a steel bracket**



**Fig. 2.3: Installation of a concrete screw anchor to fasten a timber beam to concrete directly through the timber element**

## 2.1 Timber wall to concrete connections

This section outlines the most common applications to connect timber walls to concrete foundations or slabs. Such connections are typically designed to withstand horizontal, vertical, or combined actions. The selection of the fixture to adopt is influenced by multiple parameters, including the timber wall build-up, the adopted insulation solution, the maximum required capacity of the fastening and the nailing pattern for attachment to the timber wall, the presence of leveling grout, and the wall's position relative to the edge of the concrete slab or foundation. Some commonly used connections between timber wall to concrete flooring/slabs/foundations (Fig. 2.4) are shown and the key features are illustrated in Table 2.1. Solutions presented here require post-installed anchors, typically expansion, screw or bonded anchors, depending on the required performance, for the further connection to concrete elements.



Fig. 2.4: Timber wall to concrete application

Table 2.1: Timber wall to concrete connections

| Application picture | Key features  |
|---------------------|---|
|                     | <p><b>Shear and tension plates</b></p> <p>Connections utilizing external metal shear plates are usually designed to carry mainly unidirectional loads (shear or tension) and, occasionally, out-of-plane forces.</p> <p>Side plates are secured to the timber panel with screws or nails, and to concrete with post-installed anchors. Several trademarked solutions are available on the market, coming in various sizes and with specified load-carrying capacity.</p> <p>The connection between panel and concrete can be done with an intermediate layer of grout, to adjust for variations in the height of the top of the concrete element.</p> <p>Post-installed expansion anchors and screw anchors are both fitting products for this application, and both can be selected based on preferences on installation and required load-carrying capacity. For higher load-bearing or close-to-the-edge applications, bonded anchors can be a more suitable option.</p>                           |
|                     | <p><b>Holdowns</b></p> <p>Holdowns are tall steel angle brackets typically designed to resist vertical uplift forces on walls.</p> <p>Several options are available on the market. Commonly, they require to be attached to the timber panel with timber screws or nails placed orthogonally to the panel itself. The connection to concrete is often achieved with a single post-installed anchor of medium to large diameter. More advanced solutions may employ diagonal timber screws and/or multiple anchors and may carry some horizontal forces but might need specifically designed notches in the timber wall for their installation.</p> <p>Post-installed expansion anchors with large diameters (M16 or M20) and bonded anchors (M16 or larger diameters) are typical choices for holdowns, due to the large forces usually transferred to the concrete. Bonded anchors are the preferred choice when the fastening point is significantly close to the edge of the concrete element.</p> |

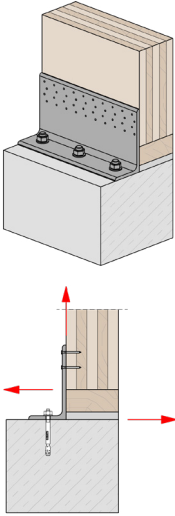
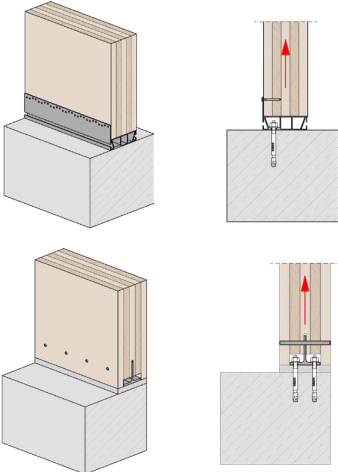
| Application picture  | Key features  |
|--|---|
|   | <p><b>Angle brackets</b></p> <p>Angle brackets can carry loads from timber panels to concrete in both vertical and horizontal directions, in- and out-of-plane. To compensate for variations in the height of the concrete surface, a layer of grout can be used under the panel.</p> <p>The timber panel is usually attached to the bracket using timber screws or nails and is fixed to concrete with post-installed anchors.</p> <p>Several trademarked solutions are available on the market, each with distinct size and load-carrying capacity.</p> <p>Post-installed expansion anchors and screw anchors are both suitable products for this application and can be selected based on installation preferences as well as required load-carrying capacity. Bonded anchors can be an option to transfer larger forces to the concrete or when significantly close to the concrete edge.</p> |
|  | <p><b>Proprietary profiles (buckets, shoes) or knife plates</b></p> <p>These connections are usually patented systems provided by specialized manufacturers or tailor-made metal elements designed for specific project requirements. They can carry vertical and horizontal loads.</p> <p>Connections can be continuous or intermittent. Buckets and shoes are typically attached to the timber panel with timber screws, while knife plates often use dowel-type fasteners. Both types of solution are normally attached to the concrete with post-installed anchors.</p> <p>The installation of the profiles can require an underlying layer of grout, based on the potential need to compensate for uneven concrete surfaces. Expansion and screw anchors are commonly used for these types of applications.</p>  |

## 2.2 Timber column to concrete connections

These connections are designed to primarily transfer vertical loads from the wooden structure to the concrete floor / foundation. The maximum actions on the connection can be limited by the timber column capacity, typically in its parallel-to-grain direction. Connections might also provide additional leveling functionality. Multiple solutions exist to meet different design requirements and aesthetic preferences, including needs for specific materials and coatings to protect against corrosion, adjustable height for the column base or concealed systems. Some timber columns to concrete connections (Fig. 2.5) are discussed in Table 2.2. The list provided here is limited to systems involving post-installed anchors (typically expansion, screw or bonded anchors, depending on required performance), and does not cover other proprietary systems.



Fig. 2.5: Timber column to concrete application

Table 2.2: Timber column to concrete connections

| Application picture | Key features  |
|---------------------|---|
|                     | <p><b>Column bears with stand-off bases (may be adjustable or not)</b></p> <p>Typically, this connection is designed to carry vertical loads and shear loads from the column to the concrete foundation.</p> <p>In such connectors, a stand-off element separates an upper bearing plate attached to the column, and a lower bearing plate fastened to the concrete using post-installed anchors. The connection to the column can be achieved via a knife plate or dowels. The connector may be adjustable in height before or after installation. Leveling with the ground may require the use of grout between the lower plate and the concrete element.</p> <p>The stand-off allows the timber element to be raised from the ground, potentially enhancing the structure durability by isolating the timber from stagnating water or other moisture sources.</p> <p>The choice of type and size of the connector can be driven by the required load carrying capacity as well as aesthetic requirements (e.g., special head/nut shape protruding through the steel baseplate).</p> <p>The required load capacity is usually the driving factor in the selection between screw, expansion or bonded anchors.</p> |
|                     | <p><b>Column bears with side plates</b></p> <p>As in the previous case, this connection is usually designed to carry vertical loads and shear loads from column to concrete.</p> <p>The column connections consist of metal side plates and a lower bearing plate. It may be realized with a single element, or multiple parts. The standard method to secure the side plates to the column is to use dowel-type connections, while the fastening of the bearing plate to the concrete is done via post-installed anchors. Grout between the bearing plate and the concrete element can be used when in need of adjusting the column elevation. Usually, no stand-off from the ground is realized.</p> <p>The choice between screw, expansion or bonded anchors is typically dictated by load requirements.</p>   |

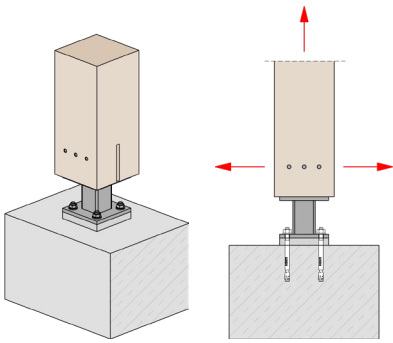
| Application picture   | Key features  |
|---|---|
|  | <p><b>Column bears with knife plate or proprietary plate connectors</b></p> <p>Besides carrying vertical loads from columns to concrete, knife plates can also provide resistance against bending moments and horizontal shear forces.</p> <p>A knife plate slots into the column and it is secured using dowel-type fasteners. The connector may be realized using hot-rolled profiles or welded plates. The bearing plate is typically fastened to concrete via post-installed anchors. Connectors which provide resistance to bending moments and shear in orthogonal directions are also available on the market. In the latter case, the knife plate is usually replaced by a cross-shaped profile.</p> <p>The choice between screw, expansion or bonded anchors is typically dependent on load requirements at the column base.</p> |

### 2.3. Timber beam to concrete connections

Timber beams may need to be connected directly to the face or the top of concrete walls or columns (e.g., to support floors or in truss structures), or to the surface of horizontal slabs (e.g. for connecting the bottom plates of timber frames to concrete foundations). In the first case, a metal connector such as a knife plate or a metal hanger is typically used; in the second one it is common to use expansion or screw anchors directly fastened through the timber beam (Fig. 2.3). Some applications for timber beam to concrete connections (Fig. 2.6) using different steel profiles or direct anchors are described in Table 2.3. As for the previous sections, the following list focuses exclusively on uses relevant to post-installed anchors.

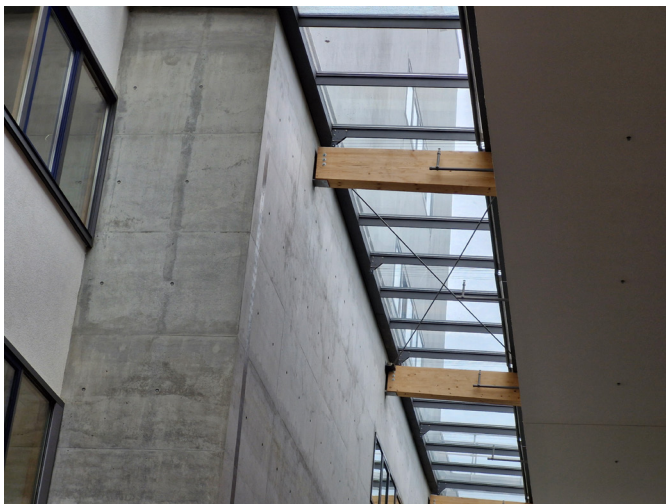
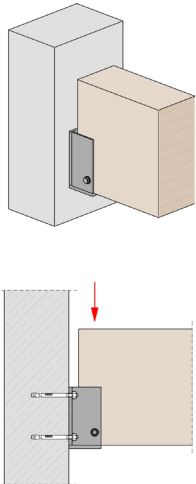
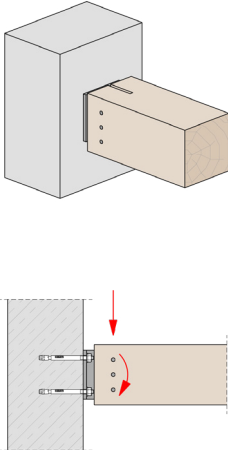
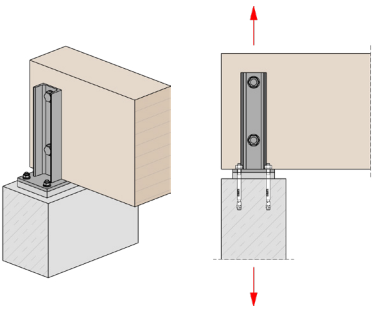
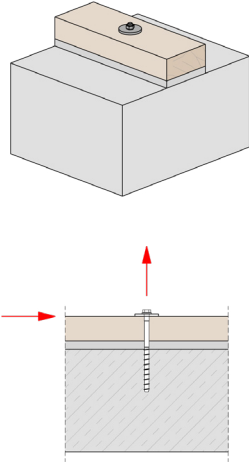

Fig. 2.6: Timber beam to concrete application

Table 2.3: Timber beam to concrete connections

| Application picture   | Key features  |
|---|---|
|    | <p><b>Metal hangers for connection to face of the wall or columns</b></p> <p>Metal hangers are used to attach timber beams onto the surface of concrete walls or columns, with the primary function to resist vertical shear loads.</p> <p>They are fixed to the beam using nails or screws and to the concrete structural element using post-installed anchors. When larger vertical forces are present, or when there are important load eccentricities, an additional bearing element at the upper section of the connector may be embedded into the concrete with grout.</p> <p>Various sizes and shapes of metal hangers exist to accommodate different beam geometries and loading requirements.</p> <p>Expansion or bonded anchors are typically chosen for these connectors. The type, quantity and diameter of the anchors are often dictated by the hanger's size, which in turn depends on the load magnitude.</p>   |
|   | <p><b>Knife plates (with or without bearing)</b></p> <p>Knife plates serve to transfer vertical loads and bending moments from beams to walls or columns.</p> <p>The connector is attached to the concrete structure with post-installed anchors. The metal plate then interlocks with the timber beam and is secured using dowel-type fasteners. For supporting larger vertical loads or when the load eccentricity is significant, an additional bearing element, directly grouted into the concrete wall, can also be included.</p> <p>While metal hangers and bucket plates are valid alternatives, knife plates can be preferred for their aesthetic advantages, since they can be often hidden from view. Specialized solutions are available in various sizes to fit different beam geometries and loading requirements.</p> <p>The type of post-installed anchor to be used for the concrete fastening is often dictated by tensile and shear capacity requirements, which also drive the size of the connector. Both mechanical and chemical bonded anchors are valid options.</p> |
|  | <p><b>Side plates for connections on column's top</b></p> <p>Side plates can act as alternatives to knife plates to transfer vertical loads from timber beams to the top of concrete columns.</p> <p>Dowel-type fasteners are employed to attach the side plate to the beam, and post-installed anchors to secure the plates to the column.</p> <p>To compensate for height differences at the column's top, a grout layer can be interposed between the column and the bearing plate.</p> <p>Both mechanical and bonded anchors are suitable solutions for these connections.</p>  |

| Application picture   | Key features  |
|---|---|
|  | <p><b>Through fastening of timber beams</b></p> <p>Securing timber beams to concrete surfaces, such as walls or slabs, often involves fastening directly through the wood into the concrete. This method is frequently employed to fix roof trusses to the face or the top of concrete walls or bottom plates in timber frame to concrete foundations.</p> <p>In these scenarios, the anchors may bear tensile, shear or combined loads. These dictate the required number of fasteners per unit length of beam, as well as the anchor dimensions. Large washers are often used to evenly distribute the acting forces across the wood element and to prevent localized damage or failure. For a more pleasing appearance, the anchors can be placed into pre-drilled recesses in the beam or countersunk screws can be used.</p> <p>Mechanical anchors are commonly utilized. Screw anchors offer particular advantages for such connections, due to their ease of installation, adjustability and reusability.</p> <p>It has to be stressed that in this application the fixture is made of timber. This condition is not covered by EN 1992-4 for design purposes.</p> |

## 2.4. Timber panel to concrete support or wall

Timber roofs and floors must be fastened to concrete walls in structures having a concrete core or concrete load-bearing skeleton. This can be achieved using external connectors such as angle brackets or custom-made fastening solutions. Angle brackets can be tailor-made continuous elements, matching the wall or panel length, or off-the-shelf solutions acting as intermittent connections evenly spaced along the panel. Additional firestop requirements need to be taken into consideration when timber panels act as a fire rated element between compartments.

The brackets can be fastened to the wall using embedded solutions (e.g. anchor channels). Alternatively, a solution often adopted is to secure the brackets to the wall with post-installed anchors. The latter option offers higher flexibility on the jobsite, allowing for adjustments or modifications after the concrete underlying structure is in place. Angle brackets transfer vertical loads from roofs or floors to the supporting walls. The brackets can be attached at the top of the wall or its side face. A grout layer may be needed for connections on top of the wall, in order to compensate for differences in elevation. Timber screws are used to connect the panels to the brackets. The latter can be fastened to the concrete walls by post-installed anchors. In this case, the most common choices are expansion and screw anchors.

Available brackets on the market vary in size and load-bearing capacity. The choice of the anchors, as well as their number and size, depends on factors such as bracket size, distance from the concrete edge and required load-bearing capacity.

## 3. Post-installed anchors

Post-installed anchors play an essential role in the construction industry in connecting structural and non-structural elements (such as beams, columns, exterior cladding, handrails, piping, etc.) to concrete structures and foundations. These types of anchors can offer specific benefits over the cast-in anchors, such as greater flexibility in design planning, along with ease of installation and inspection. They are typically categorized according to their load-transfer mechanisms and their installation methods.

Given their critical role in ensuring the safety of structural and non-structural connections, post-installed anchors must undergo proper testing and qualification processes. They must also be designed according to relevant and up-to-date standards, code and regulations. Several factors can affect their performance and reliability, including the type and condition of the base material, load types and direction, concrete edge distance and anchor spacing, the installation process and environmental exposure, among others.

This chapter presents a brief overview of the main types of post-installed anchors, their working principles, potential failure modes and key considerations for design. For those seeking a more in-depth guide to the functioning, qualification and design of post-installed anchors, we encourage you to review the Steel-to-Concrete (S2C) handbook provided by Hilti [4], which is freely accessible for download on our website.

**Note:** S2C handbook provides guidance for post-installed anchors in steel-to-concrete connections.



### 3.1. Post-installed mechanical and bonded anchors

Post-installed anchors are designed primarily to transfer loads from a structural or non-structural element to the base material (in this case concrete). Different types of anchors use varying load-transfer mechanisms. Although analyzing every anchor technology and their working principles goes beyond the scope of this handbook, it is important describing the most utilized ones.

Most post-installed anchors fall into two categories: mechanical anchors and bonded (or chemical) anchors. They rely on the three main load-bearing mechanisms: mechanical interlock, friction, and adhesive bond (see Fig. 3.1).

- **Mechanical interlock/keying** happens when the load transfer is achieved by a bearing interlock generated via a notch or undercut in the base material. The latter is purposely created using either a specialized drill bit or by the anchor's undercutting action during installation (Fig. 3.1 a).
- **Friction** typically arises in fastening systems relying on expansion forces generated by a sleeve or wedge pressing against the borehole's lateral surface. These expansion forces equilibrate the external tensile forces acting on the anchor (Fig. 3.1 b).
- **Adhesive bonding** requires an external material, like an adhesive resin or mortar, which is directly inserted into the borehole to create a chemical adhesion with the base material. The load transfer between the metal anchor (typically a threaded rod) and the base material is achieved by a combination of micro-interlock (between the metal rod and the chemical mortar) and chemical bonding (between the mortar and the borehole's surface) (Fig. 3.1 c).



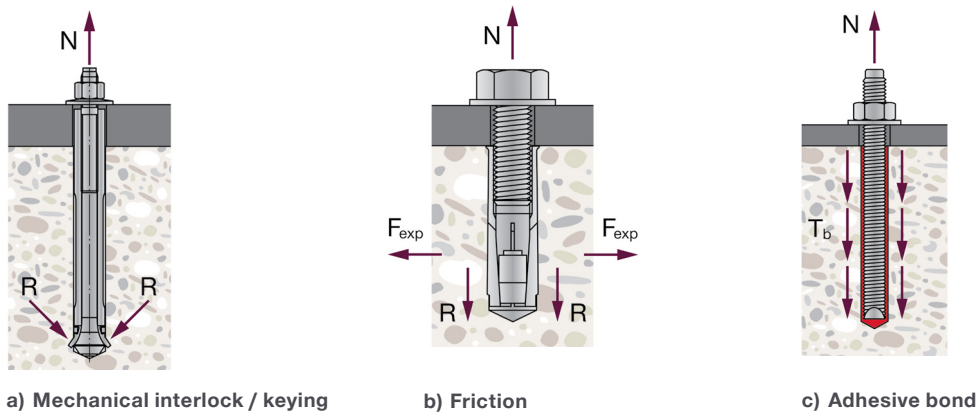

Fig. 3.1: Main load-bearing mechanisms in post-installed anchor technologies

### 3.1.1. Mechanical anchors

Mechanical anchors are usually classified under three main categories (see Fig. 3.2):

- **Expansion anchors** include a threaded bolt or rod with a cone tip, an expansion sleeve and a nut and washer (Fig. 3.2 a). They achieve their load-carrying capacity by creating friction through the expansion of the sleeve against the sides of the pre-drilled borehole. Expansion anchors can be torque-controlled or displacement-controlled. In the first case, the sleeve expansion is achieved by applying a pre-defined torque on the nut which forces the cone tip into the sleeve. In the second one, the expansion of the sleeve is obtained by forcing the sleeve over the cone, typically using impact forces. Expansion anchors are mostly used for light or medium-duty applications.
- **Undercut anchors** consist of a threaded stud with conical end, an undercut sleeve, plus a nut and washer (Fig. 3.2 b). They rely on mechanical interlock achieved by an undercut geometry at the embedded tip, either created by a special drill bit, or by the anchor itself during installation. These anchors often achieve higher performance but require more complex installation and generally lead to higher costs.
- **Screw anchors** feature a hexagonal or countersunk head bolt with an outer thread (Fig. 3.2 c). They are installed by screwing in a pre-drilled borehole, without the need of a nut or washer. They derive their load-carrying capacity from the mechanical interlock of the outer thread with the base material, created during installation by undercutting the base material throughout the length of the borehole. Screw anchors are usually characterized by easy and quick installation and better finishing thank to several different available head shapes (see [Section 4.3](#)). They are typically suited for light and medium-duty, as well as temporary applications.

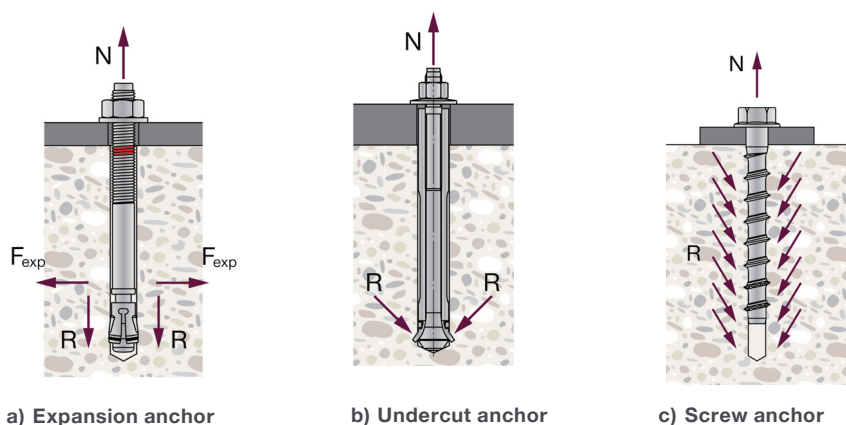

Fig. 3.2: Main mechanical anchor types

### 3.1.2. Bonded anchors

Bonded anchors usually combine a steel threaded rod and an adhesive mortar, which acts at the interface between the base material and the steel part (see Fig. 3.1 c). The adhesive mortar can be organic (e.g., epoxy, polyester, vinyl-ester) or inorganic (i.e., cement-based). It usually consists of a resin and a hardener component, which are mixed together during installation and must cure properly (the curing time depends on the product and the environmental conditions). The mortar is commonly delivered in injectable cartridges and foil pack systems, or in glass or foil capsules. The installation of bonded anchors is more cumbersome than mechanical ones because it requires additional installation steps and curing. Bonded anchors generally outperform mechanical anchors in terms of tensile resistance, thanks to their deeper embedment depth, which engages a larger volume of base material.

## 3.2. Failure modes and main influencing factors

Depending on load directions and an anchor's load-transfer mechanism, different failure modes can occur if the forces acting on the anchor exceed its resistance or that of the concrete. Employing a higher grade of steel or higher concrete strength may usually lead to increased anchor performance. Yet, essential design variables, such as an anchor's diameter, embedment depth, spacing within anchor groups and distance from the concrete edge, also significantly affect an anchor's performance. International codes and regulations, such as EN 1992-4 [2] provide design formulae to verify an anchor's capability to withstand each failure mode, identify which failure mode is the most critical for the fastening point and validate the connection safety. Structural engineers can use specialized software, such as Hilti PROFIS Engineering Suite, as an efficient aid to comply with international standards.

The following sections ([Section 3.2.1](#) and [3.2.2](#)) of this document provide a brief overview of the critical failure modes for post-installed anchors, which must be verified according to EN 1992-4 [2]. Furthermore, [Section 3.3](#) briefly introduces qualification and assessment scope within the European framework. Detailed design calculations for each failure mode, following EN 1992-4 [2] prescriptions, are then presented for some selected design cases in [Chapter 5](#).

### 3.2.1. Failure modes under tensile loads

- **Steel failure** (Fig. 3.3 a): This type of failure occurs when the tensile stress at the smallest cross-section of the anchor exceeds its ultimate steel resistance, leading to rupture without significant concrete damage. Increasing the anchor diameter, adding more anchors, or selecting anchors with higher steel grade can improve the system's capacity to withstand this failure mode.
- **Concrete cone failure** (Fig. 3.3 b): This failure mode is characterized by the formation of a cone-shaped volume, which is pulled-out from the base material along with the anchor. The fracture surface originates when the stress in the load-transfer zone of the anchor exceeds the concrete resistance. The anchor's capacity to withstand this failure mode can be improved by enlarging the concrete cone volume, which can be achieved by increasing the anchor embedment depth, the spacing between the anchors in a group and the distance of the anchors from the edge of the concrete.
- **Pull-out failure** (Fig. 3.3 c): Relevant for mechanical anchors, pull-out failure arises when the entire anchor is extracted from the borehole without further significant damage to the base material or the anchor itself. This typically occurs when the tensile forces acting on the anchor exceed the maximum friction between the anchor sleeve and the borehole's lateral surface. The sensitivity of an anchor to this failure mode is strictly product dependent and can be checked in the relevant approval document.

- **Combined pull-out and concrete cone failure** (Fig. 3.3 d): Relevant for bonded anchors, this failure mode is a combination of pull-out (due to the loss of bond between the anchor and the concrete) and a shallow concrete cone, manifesting near to the concrete surface. Being a combination of pull-out and concrete cone, improvement in the anchor capacity can be obtained by increasing the anchor diameter and embedment depth, as well as the anchor spacing and distance from the edge of the concrete.
- **Concrete splitting failure** (Fig. 3.3 e): This failure mode is triggered by expansion forces exceeding the maximum concrete tensile resistance, or as the result of the anchor installation at small edge distances and small concrete member thicknesses. The anchor utilization with respect to this failure mode improves for larger concrete edge distances and concrete member thicknesses, along with larger anchor spacing.
- **Concrete blow-out failure** (Fig. 3.3 f): Specific to undercut anchors, it is caused by forces transverse to the load direction caused by high-bearing pressure stresses. These forces can result into a breakout on the side face of the concrete member, particularly when the anchors are placed close to the concrete member edge

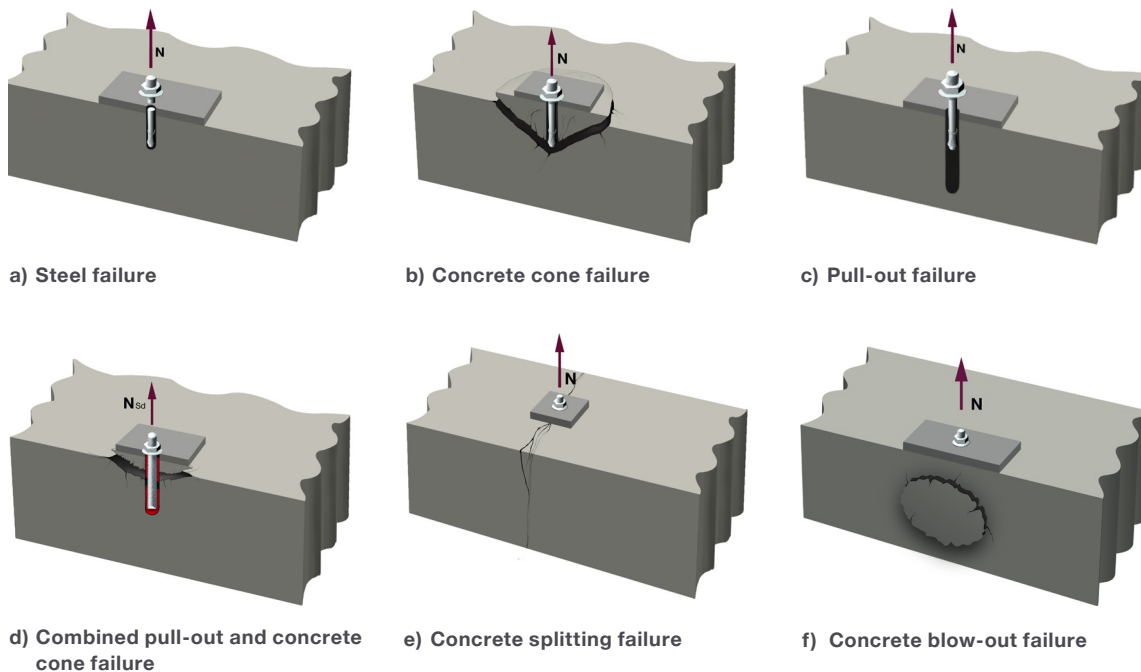

Fig. 3.3: Failure modes under tension loading

### 3.2.2. Failure modes under shear loads

- **Steel failure** (Fig. 3.4 a): Similar to its tensile counterpart, this failure mode occurs when the shear stress in the anchor's smallest cross-section exceeds the ultimate steel resistance, causing the anchor to shear off without substantial concrete damage. Applying shear with a lever arm relative to the concrete surface reduces the anchor's resistance due to the additional bending moment on the anchor and resulting additional tensile stress. Increasing the anchor's diameter, the number of anchors or selecting anchors with higher steel grade can improve the fastening resistance to this failure mode.
- **Concrete pry-out failure** (Fig. 3.4 b): This type of failure primarily happens when the anchor is embedded at a shallow depth. It is caused by the anchor's rotation due to the eccentricity between the acting shear force and the resultant resisting force in the concrete. This causes the concrete to break in tension on the side opposite the shear load direction, ejecting a small volume of concrete. Factors that influence this failure mode are the same influencing the anchor concrete cone resistance

and the combined pull-out and concrete cone resistance (for bonded anchors).

- **Concrete edge failure** (Fig. 3.4 c): This failure mode may occur when the anchors are placed close to an edge of the concrete member. The failure in this case is characterized by a cone of concrete breaking out at the concrete edge. The fracture originates at the anchor's shaft and propagates till the lateral surface of the concrete member. Increasing the anchor's diameter and embedment depth, as well as placing the anchors further from the edge can improve anchor performance.

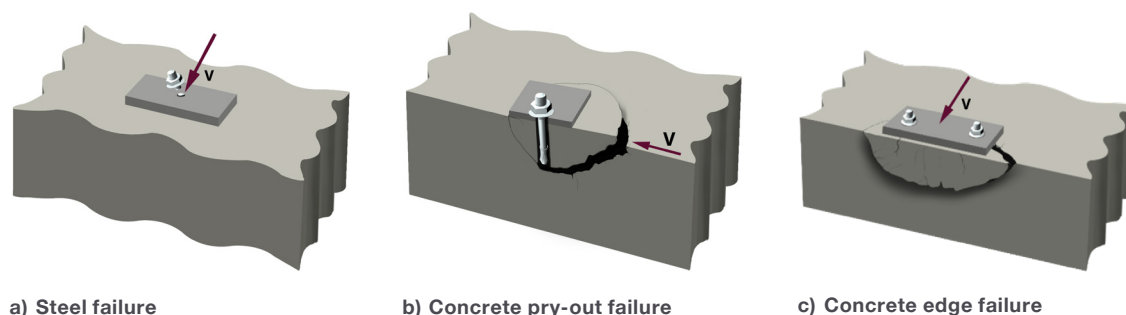

Fig. 3.4: Failure modes under shear loading

### 3.2.3. Other factors influencing the anchor performance

As previously discussed, the performance of an anchor against each failure mode is influenced by multiple design variables. In addition, other external factors can influence the overall behavior of the anchor under an applied external load. In this section, a brief overview of the key parameters to consider during the design of connections using post-installed anchors is given (refer to Fig. 3.5).

- **Base material:** The concrete strength class influences concrete-related failure modes under tension and shear loading. In general, higher concrete strength implies better anchor performance, although the improvement varies with the anchor type. Cracks in concrete can reduce the load-carrying capacity of the anchor. International codes and standards, such as EN 1992-4 [2], differentiate between the verification of fastening points in cracked or uncracked concrete. These conditions are modelled into the provided design equations, which account for reduced performance in cracked concrete scenarios.
- **Installation:** Installation affects the final anchor's performance through key factors such as drilling technique, hole size, cleaning process, correct setting and torquing. Installation according to the manufacturer's instruction for use ensures the full load-carrying capacity of anchors is activated.
- **Environmental conditions:** External environmental conditions can degrade the anchor's performance and durability. For example, bonded anchors are less performant at high temperatures. Humidity, atmospheric salinity or atmospheric contaminants such as sulfur dioxide increase the corrosion rate on many metals, making stainless steel a better choice for anchor materials to preserve the anchor functionality over its service life. Conditions such as temperature variations, humidity and atmospheric contamination cycles, should all be considered when selecting anchor technologies and materials.
- **Loading types:** While static loads are the most common scenario, in several instances the structural engineer must consider acting sustained loads, dynamic loads (e.g., seismic or fatigue loads) or fire exposure. The Anchor's performance must be quantified and assessed for specific loading conditions. International codes and regulations dictate the appropriate qualification processes, approval standards and design methodologies to appropriately determine the anchor's capacity under different loading types.

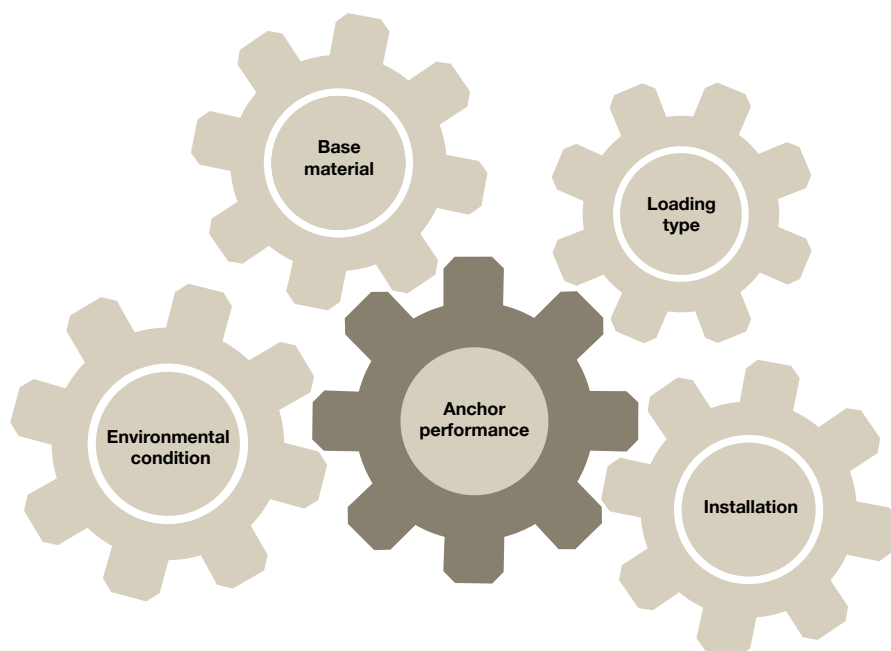

Fig. 3.5: External criteria influencing anchor performance

### 3.3. Qualification and design of post-installed anchors

The performance assessment of post-installed anchors in most European countries is regulated by the European Organization for Technical Assessment (EOTA). This organization includes the Technical Assessment Bodies (TABs, e.g. DIBT in Germany, CSTB in France), designated by the member states of the European Union and the European Economic Area.

The EOTA publishes the European Assessment Documents (EADs), which describe in detail the required assumptions and tests for the assessment of anchors' essential performance characteristics, and their qualification criteria. Each EAD addresses a specific type of anchor, since different technologies may require different qualification processes.

For a specific product, manufacturers must appoint TABs to issue a European Technical Assessment (ETA) document. The latter outlines, for the selected product, the certified installation methods and the performance characteristics for approved base materials and load conditions, assessed according to the relevant EAD.

Finally, the design of post-installed anchors is regulated by the provisions of the Eurocode 2 part 4 (EN 1992-4 [2]). The primary scope of EN 1992-4 [2] covers single and groups of fasteners in normal weight concrete, at ultimate and serviceability limit states. It encompasses anchors' design for static, seismic and fatigue loads, and, for mechanical anchors, exposure to fire. EN 1992-4 [2] also specifies requirements for anchors' durability for various corrosion exposure classes. The design equations, proposed in EN 1992-4 [2] for the verification of the anchor's utilization, adopt the anchor's parameters contained in the ETA for the load conditions and geometric configurations defined by the structural engineer.

### 3.4. PROFIS Engineering: a powerful software for efficient design

Designing post-installed anchors manually can be cumbersome. Achieving an optimized solution while ensuring compliance with international codes such as EN 1992-4 [2] can become a time-consuming process. For efficiency, structural engineers can consider specialized software to design the connections.

If you are looking for a reliable, fast and simple way to design and specify post-installed anchors, Hilti PROFIS Engineering is a powerful software that enables users to analyze and optimize fastening applications in accordance with the latest international codes and standards.

PROFIS Engineering is a comprehensive structural analysis tool, whose user-friendly interface allows for the creation of 3D models of anchoring applications, including baseplates, steel members, anchors and concrete geometry (Fig. 3.6).

It incorporates a comprehensive set of design codes and standards from multiple countries. It supports various load scenarios including static, seismic and fatigue loads, as well as fire exposure. It includes an extensive, up-to-date database of Hilti fastening products.

PROFIS Engineering enables you to compare different anchor types and configurations to select the most cost-effective solution for your project. The software generates comprehensive design reports with reference to the state-of-the-art design methods. It integrates with other structural analysis software suites (e.g. RISACONNECTION, RAM Structural System, STAAD.Pro, SAP 2000, ETABS, Robot, Revit and Dlubal RFEM and RSTAB), and allows exporting final designs to integrate them into standard BIM and CAD programs.

As a cloud-based solution, PROFIS Engineering can be accessed through any web browser, without needing local installation, offering saving and syncing of projects across multiple devices and automatic updates, which complements the technical support from our experts.

PROFIS Engineering helps saving you time, money and resources. Whether you are working on a small or large project, it will help you achieving the best results in the shortest time. **Try it for free today and discover how you can enhance your engineering performance and productivity.**

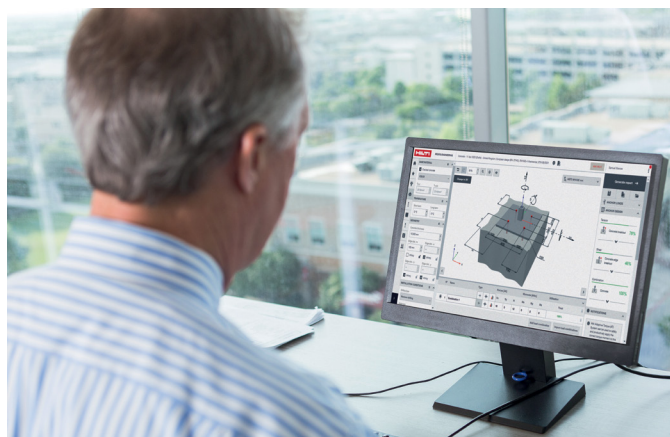

Fig. 3.6: PROFIS Engineering suite for post-installed concrete anchor connections

### 3.5. Typical Hilti post-installed anchors for Timber to concrete applications

Some common timber to concrete applications have been discussed in [Chapter 2](#). The timber sections are usually connected to concrete using some steel elements with post-installed anchors. Hilti is a leading innovator in the development and production of post-installed anchors, known for their wide offering of mechanical and bonded anchors, among other products, suiting a variety of applications. Hilti anchors fit applications in different base materials and jobsite conditions, and are accompanied by extensive technical documentation, software and engineering support. Structural engineers can rely on Hilti's expertise and advanced products and services, which are designed to help ensuring safety, durability, performance and ease of installation. Hilti anchors are backed by rigorous testing, are qualified and approved for use in uncracked and cracked concrete, static and dynamic loads, and under fire exposure, to support specifiers in tackling the most challenging projects.

Based on Hilti's long-term experience in post-installed anchors, this technical handbook aims to provide technical guidance on fastening timber structural and non-structural elements to concrete. In particular, this section presents a general overview of the most common solutions in timber construction in [Chapter 2](#). This section, further highlights the main Hilti products for various applications in Table 3.1 to Table 3.4.

Table 3.1: Wall-to-concrete connections – most commonly used anchor sizes

| Suitable Hilti anchors |                     | Shear and tension plates | Holdowns      | Angle steel brackets | Proprietary profiles |
|------------------------|---------------------|--------------------------|---------------|----------------------|----------------------|
| Expansion              | HST4 HST4-R         | M10, M12, M16            | M12, M16, M20 | M10, M12             | M10, M12             |
|                        | HST2 V3             | M16                      | M16           | M12, M16             | M12, M16             |
| Screw                  | HUS4 (-H, -C, -A)   | d12, d14, d16            | -             | d10, d12, d14        | d10, d12             |
|                        | HUS4 (-HR, -CR)     | d14                      | -             | d10, d14             | d10                  |
| Bonded                 | HY 200 + HAS U rods | M12, M16                 | M16, M20, M24 | M10, M12, M16        | -                    |
|                        | HVU2 + HAS U rods   | M12, M16                 | M16, M20, M24 | M10, M12, M16        | -                    |

Table 3.2: Column-to-concrete connections – most commonly used anchor sizes

| Suitable Hilti anchors |                     | Stand-off base | Side plates  | Knife plate        |
|------------------------|---------------------|----------------|--------------|--------------------|
| Expansion              | HST4 HST4-R         | M10, M12       | M8, M10      | M8, M10, M12       |
|                        | HST2 V3             | M12, M16       | M10, M12     | M12, M16           |
| Screw                  | HUS4 (-H, -C, -A)   | d10, d12, d14  | d10, d12     | d10, d12, d14, d16 |
|                        | HUS4 (-HR, -CR)     | d10, d14       | d10          | d10, d14           |
| Bonded                 | HY 200 + HAS U rods | M10, M12       | M8, M10, M12 | M10, M12, M16      |
|                        | HVU2 + HAS U rods   | M10, M12       | M8, M10, M12 | M10, M12, M16      |

Table 3.3: Beam-to-concrete connections – most commonly used anchor sizes

| Suitable Hilti anchors |                     | Metal hangers      | Knife plates       | Side plates | Through fastening |
|------------------------|---------------------|--------------------|--------------------|-------------|-------------------|
| Expansion              | HST4 HST4-R         | M10, M12           | M10, M12           | M10, M12    | M10, M12          |
|                        | HST2 V3             | M12, M16           | M12, M16           | M12         | M12, M16          |
| Screw                  | HUS4 (-H, -C, -A)   | d10, d12, d14, d16 | d10, d12, d14, d16 | d10, d12    | d12, d14, d16     |
|                        | HUS4 (-HR, -CR)     | d10, d14           | d10, d14           | d10         | d14               |
| Bonded                 | HY 200 + HAS U rods | M12, M16           | M12, M16           | M10, M12    | -                 |
|                        | HVU2 + HAS U rods   | M12, M16           | M12, M16           | M10, M12    | -                 |

Table 3.4: Panels-to-concrete – most commonly used anchor sizes

| Suitable Hilti anchors |                     | Angle brackets |
|------------------------|---------------------|----------------|
| Expansion anchors      | HST4 HST4-R         | M10, M12       |
|                        | HST2 V3             | M12, M16       |
| Screw anchors          | HUS4 (-H, -C, -A)   | d10, d12, d14  |
|                        | HUS4 (-HR, -CR)     | d10, d14       |
| Bonded anchors         | HY 200 + HAS U rods | M10, M12, M16  |
|                        | HVU2 + HAS U rods   | M10, M12, M16  |



## 4. Technical data / properties of main Hilti post-installed anchors

This section of the handbook details the most frequently used Hilti expansion, screw and bonded anchors for timber-to-concrete connections described in [Chapter 3](#).

For each type of anchor, it provides information on sizes, approvals, and reference installation parameters and design resistances for single anchors in both uncracked and cracked concrete under static and seismic loads. For seismic condition, design resistance values are mentioned without Hilti filling set.

The numerical values in the following tables are applicable only to the reference fastening configuration specific to each section. It's advisable to validate your calculations using Hilti's PROFIS Engineering software, as installation parameters and load resistances can vary based on design factors like geometry of the fastening point, load conditions, concrete quality, etc. Additionally, for anchor groups and simultaneous tensile and shear loads, proper validation of the anchor's utilization individually and within a group must be properly verified following the standards set out in EN 1992-4 [2], as shown in the design examples presented in [Chapter 5](#).

The notation used in the tables included in this chapter is the following (see Fig. 4.1 for definition of relevant geometrical parameters):

|           |   |
|-----------|---|
| $h_{ef}$  | anchor's effective embedment depth  |
| $h_{nom}$ | anchor's nominal embedment depth  |
| $h_{min}$ | minimum concrete member thickness required for the specified anchor embedment |
| $s_{min}$ | minimum spacing between anchors   |
| $s$       | actual spacing between anchors  |
| $c_{min}$ | minimum distance between anchor and concrete edge                             |
| $c$       | actual distance between anchor and concrete edge                              |
| $N_{Rd}$  | design resistance to tensile loads  |
| $V_{Rd}$  | design resistance to shear loads  |

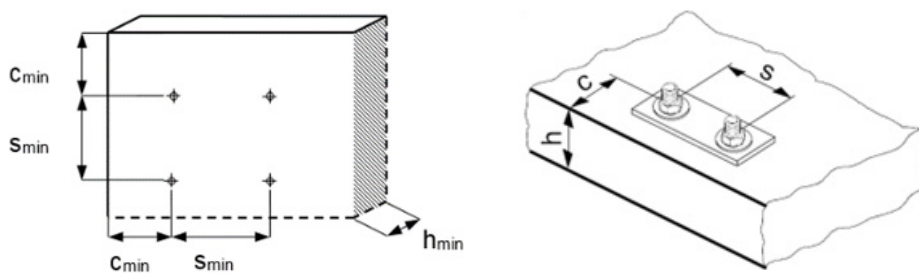

Fig. 4.1: Edge distance, spacing and concrete slab thickness



**Note:** By using the Hilti filling set, the seismic shear resistance is improved significantly as the gap factor,  $\alpha_{gap} = 1.0$  is considered in design.













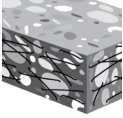

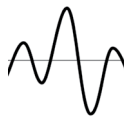
**Note:** For more details, please refer to Hilti Fastening Technology Manual (FTM) [5].

## 4.1. Hilti HST4 (-R) Expansion anchor

### High-performance expansion anchor

| Anchor version   |                                 | Benefits  |
|--|---------------------------------|---|
|   | HST4-R<br>HST4<br>(M8 - M20)    | <ul style="list-style-type: none"> <li>High capacity anchor with ability to be used in reduced member thickness, small spacing and edge distances</li> <li>Suitable for uncracked and cracked concrete C20/25 to C50/60</li> </ul>  |
|   | HST4-R DN<br>HST4<br>(M8 - M16) | <ul style="list-style-type: none"> <li>Tested and approved for structural seismic design with ETA C1/C2 assessment</li> <li>Longer embedment depth option to get higher resistance, closer distance to the edge or smaller spacing</li> <li>Full design flexibility with variable embedment depth and edge &amp; spacing</li> </ul> |
|  | HST4-R BW<br>HST4<br>(M8 - M16) | <ul style="list-style-type: none"> <li>Faster and reliable installation thanks to approved non-cleaning and adaptive torqueing tool</li> <li>Dome-nut variant available for more aesthetic application finish</li> <li>Product length identification mark facilitates quality control and inspection</li> </ul>                     |

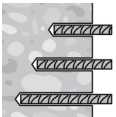
| Base material   |   |   | Load conditions   |   |  |   |
|---|---|---|---|---|--|---|
|  |  |  |  |  |  |  |
| Concrete (uncracked)  | Concrete (cracked)  | Steel fibre reinforced concrete   | Static/quasi-static   | Seismic C1/C2   | Fire resistance  | Shock BZS-CH  |

| Drilling, cleaning, setting   |   |   |   | Other information   |  |   |
|---|---|---|---|---|--|---|
|  |  |  |  |  |  |  |
| Hammer drilled holes (with no cleaning)   | Diamond drilled holes   | Hollow drill-bit drilling   | Impact wrench with adaptive torque module   | Variable embedment depth  | PROFIS Engineering software  | Steel to concrete Handbook  |

**Linked Approvals/Certificates**

**Approvals/certificates**

| Approval no                 | Application / loading condition          | Authority / Laboratory | Date of issue |
|-----------------------------|--|------------------------|---------------|
| <a href="#">ETA-21/0878</a> | Static and quasi-static / Seismic / Fire | CSTB, Marne-la-Vallée  | 31-10-2024    |

Link to Hilti webpage for more detail information and Instructions for use

|   |   |   |
|---|---|---|
| <a href="#">HST4-R</a>  | <a href="#">HST4-R DN</a>   | <a href="#">HST4-R BW</a>   |
|  |  |  |
| <a href="#">HST4</a>  | <a href="#">HST4 DN</a>   | <a href="#">HST4 BW</a>   |
|  |  |  |

**4.1.1. Minimum concrete slab thickness, edge distance and spacing**

The ETA-21/0878 [6] provides the formulae to assess minimum requirements for flexible edge distance and spacing for each anchor layout configuration, which vary according to the base material thickness and the anchor embedment depth (Fig. 4.1). Table 4.1 and Table 4.2 recommend minimum edge distances and spacing for specific anchor layouts and base material sizes. Minimum concrete slab thickness is shown for maximum and minimum embedment depth. Minimum spacing and edge distance have been presented for concrete slab thickness of 300 mm.

Table 4.1: HST4-R: Definitions of minimum concrete thickness, edge distance and spacing

| Uncracked concrete |                    |                |                |                 |                   |                       |                   |
|--------------------|--------------------|----------------|----------------|-----------------|-------------------|-----------------------|-------------------|
|                    | Cleaned drill hole |                |                | Minimum spacing |                   | Minimum edge distance |                   |
| Size               | $h_{ef}$ [mm]      | $h_{nom}$ [mm] | $h_{min}$ [mm] | $s_{min}$ [mm]  | For $c \geq$ [mm] | $c_{min}$ [mm]        | For $s \geq$ [mm] |
| M8                 | 30                 | 36             | 80             | 35              | 70                | 40                    | 120               |
|                    | 90                 | 96             | 135            | 35              | 45                | 40                    | 65                |
| M10                | 30                 | 38             | 80             | 40              | 100               | 45                    | 205               |
|                    | 100                | 108            | 150            | 40              | 55                | 45                    | 100               |
| M12                | 40                 | 49             | 100            | 50              | 125               | 55                    | 255               |
|                    | 125                | 134            | 190            | 50              | 70                | 55                    | 120               |
| M16                | 65                 | 77             | 120            | 65              | 115               | 65                    | 210               |
|                    | 160                | 172            | 240            | 65              | 70                | 65                    | 80                |
| M20                | 101                | 116            | 160            | 90              | 140               | 80                    | 260               |
|                    | 180                | 195            | 270            | 90              | 90                | 80                    | 140               |
| Cracked concrete   |                    |                |                |                 |                   |                       |                   |
|                    | Cleaned drill hole |                |                | Minimum spacing |                   | Minimum edge distance |                   |
| Size               | $h_{ef}$ [mm]      | $h_{nom}$ [mm] | $h_{min}$ [mm] | $s_{min}$ [mm]  | For $c \geq$ [mm] | $c_{min}$ [mm]        | For $s \geq$ [mm] |
| M8                 | 30                 | 36             | 80             | 35              | 50                | 40                    | 55                |
|                    | 90                 | 96             | 135            | 35              | 40                | 40                    | 35                |
| M10                | 30                 | 38             | 80             | 40              | 80                | 45                    | 145               |
|                    | 100                | 108            | 150            | 40              | 50                | 45                    | 55                |
| M12                | 40                 | 49             | 100            | 50              | 95                | 55                    | 160               |
|                    | 125                | 134            | 190            | 50              | 60                | 55                    | 55                |
| M16                | 65                 | 77             | 120            | 65              | 100               | 65                    | 160               |
|                    | 160                | 172            | 240            | 65              | 65                | 65                    | 65                |
| M20                | 101                | 116            | 160            | 90              | 100               | 80                    | 145               |
|                    | 180                | 195            | 270            | 90              | 80                | 80                    | 90                |

Note: The minimum spacing and edge distance depend on the effective embedment depth, minimum concrete slab thickness and actual slab thickness. All values are provided for cleaned borehole. Please refer to ETA-21/0878 for all other conditions.

Table 4.2: HST4: Definitions of minimum concrete thickness, edge distance and spacing

| Uncracked concrete |                    |                |                |                 |                   |                       |                   |
|--------------------|--------------------|----------------|----------------|-----------------|-------------------|-----------------------|-------------------|
|                    | Cleaned drill hole |                |                | Minimum spacing |                   | Minimum edge distance |                   |
| Size               | $h_{ef}$ [mm]      | $h_{nom}$ [mm] | $h_{min}$ [mm] | $s_{min}$ [mm]  | For $c \geq$ [mm] | $c_{min}$ [mm]        | For $s \geq$ [mm] |
| M8                 | 30                 | 36             | 80             | 35              | 70                | 40                    | 120               |
|                    | 90                 | 96             | 135            | 35              | 45                | 40                    | 65                |
| M10                | 30                 | 38             | 80             | 40              | 100               | 45                    | 205               |
|                    | 100                | 108            | 150            | 40              | 55                | 45                    | 100               |
| M12                | 40                 | 49             | 100            | 50              | 125               | 55                    | 255               |
|                    | 125                | 134            | 190            | 50              | 70                | 55                    | 120               |
| M16                | 65                 | 77             | 120            | 65              | 140               | 65                    | 290               |
|                    | 160                | 162            | 240            | 65              | 80                | 65                    | 135               |

| Uncracked concrete |                    |                |                |                 |                   |                       |                   |
|--------------------|--------------------|----------------|----------------|-----------------|-------------------|-----------------------|-------------------|
| M20                | 101                | 116            | 160            | 90              | 140               | 80                    | 260               |
|                    | 180                | 195            | 270            | 90              | 90                | 80                    | 140               |
| Cracked concrete   |                    |                |                |                 |                   |                       |                   |
|                    | Cleaned drill hole |                |                | Minimum spacing |                   | Minimum edge distance |                   |
| Size               | $h_{ef}$ [mm]      | $h_{nom}$ [mm] | $h_{min}$ [mm] | $s_{min}$ [mm]  | For $c \geq$ [mm] | $c_{min}$ [mm]        | For $s \geq$ [mm] |
| M8                 | 30                 | 36             | 80             | 35              | 50                | 40                    | 55                |
|                    | 90                 | 96             | 135            | 35              | 40                | 40                    | 35                |
| M10                | 30                 | 38             | 80             | 40              | 80                | 45                    | 145               |
|                    | 100                | 108            | 150            | 40              | 50                | 45                    | 55                |
| M12                | 40                 | 49             | 100            | 50              | 95                | 55                    | 160               |
|                    | 125                | 134            | 190            | 50              | 60                | 55                    | 55                |
| M16                | 65                 | 77             | 120            | 65              | 105               | 65                    | 175               |
|                    | 160                | 172            | 240            | 65              | 65                | 65                    | 65                |
| M20                | 101                | 116            | 160            | 90              | 100               | 80                    | 145               |
|                    | 180                | 195            | 270            | 90              | 80                | 80                    | 90                |

**Note:** The minimum spacing and edge distance depend on the effective embedment depth, minimum concrete slab thickness and actual slab thickness. All values are provided for cleaned borehole. Please refer to ETA-21/0878 for all other conditions.

#### 4.1.2. Static, quasi-static and seismic C2 anchor design resistance

EN 1992-4 [2] provides formulae for the calculation of the design resistance with variable embedment depth, considering edge distance and spacing for each anchor layout configuration according to the performance data indicated in the relevant ETA-21/0878 [6] (refer to Table 4.3 and Table 4.4). All data in this section apply to:

- Correct setting (please refer to setting details in the anchor Instructions for Use)
- Single anchor, with no edge distance and spacing influence
- Minimum base material thickness
- Concrete grade C20/25
- Hammer drilled and diamond cored holes (M8 to M20), hammer drilled holes with Hilti hollow drill bit (M10-M20)
- Reference embedment depths as specified in the table. HST4 and HST4-R are approved for design with variable embedment depth, within ranges specified in ETA-21/0878 [6]

**Note:** according to EN 1992-4 [2], effective embedment depths smaller than 40 mm are allowed only for non-structural redundant systems, i.e., when the load can be distributed to other fasteners in case of failure of singly fastening points, following the provisions of CEN/TR 17079 [7]. For seismic actions, HST4 and HST4-R M8 and M10 effective embedment depths smaller than 40 mm have been tested and included in the approval documentation (please refer to ETA-21/0878 [6]), however EN 1992-4 [2] does not cover embedment depths smaller than 40 mm for seismic loads.

Table 4.3: HST4-R: Design resistance at minimum and maximum effective embedment depth

| Size | $h_{ef}$ [mm] | Uncracked concrete |               | Cracked concrete |               | Seismic C2    |                |
|------|---------------|--------------------|---------------|------------------|---------------|---------------|----------------|
|      |               | $N_{Rd}$ [kN]      | $V_{Rd}$ [kN] | $N_{Rd}$ [kN]    | $V_{Rd}$ [kN] | $N_{Rd}$ [kN] | $V_{Rd}$ [kN]* |
| M8   | 47            | 10.6               | 13.9          | 6.7              | 13.9          | 3.0           | 8.2            |
|      | 90            | 12.7               | 13.9          | 6.7              | 13.9          | 3.3           | 8.2            |
| M10  | 60            | 17.6               | 22.0          | 12.3             | 22.0          | 8.4           | 14.9           |
|      | 100           | 21.3               | 22.0          | 13.3             | 22.0          | 8.5           | 15.0           |
| M12  | 40            | 9.6                | 23.9          | 6.7              | 16.8          | 5.7           | 14.3           |
|      | 125           | 30.7               | 33.0          | 18.7             | 33.0          | 14.7          | 19.2           |
| M16  | 65            | 19.8               | 57.9          | 13.9             | 41.7          | 11.8          | 35.5           |
|      | 160           | 40.0               | 57.9          | 25.3             | 57.9          | 24.5          | 41.0           |
| M20  | 101           | 33.3               | 77.8          | 23.3             | 74.6          | 19.8          | 53.9           |
|      | 180           | 33.3               | 77.8          | 23.3             | 77.8          | 23.3          | 53.9           |

\*with Hilti filling set

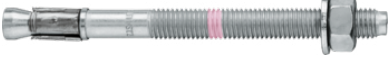



Table 4.4: HST4: Design resistance at minimum and maximum effective embedment





| Size | $h_{ef}$ [mm] | Uncracked concrete |               | Cracked concrete |               | Seismic C2    |                |
|------|---------------|--------------------|---------------|------------------|---------------|---------------|----------------|
|      |               | $N_{Rd}$ [kN]      | $V_{Rd}$ [kN] | $N_{Rd}$ [kN]    | $V_{Rd}$ [kN] | $N_{Rd}$ [kN] | $V_{Rd}$ [kN]* |
| M8   | 47            | 10.6               | 13.0          | 7.4              | 13.0          | 2.9           | 8.6            |
|      | 90            | 12.7               | 13.0          | 8.0              | 13.0          | 3.1           | 8.6            |
| M10  | 60            | 16.4               | 19.8          | 12.3             | 19.8          | 8.3           | 14.2           |
|      | 100           | 20.0               | 19.8          | 12.7             | 19.8          | 8.3           | 14.2           |
| M12  | 40            | 9.6                | 23.9          | 6.7              | 16.8          | 5.6           | 14.3           |
|      | 125           | 28.0               | 29.9          | 18.7             | 29.9          | 14.4          | 21.2           |
| M16  | 65            | 19.8               | 50.3          | 13.9             | 41.7          | 11.8          | 31.1           |
|      | 160           | 36.7               | 50.3          | 25.3             | 50.3          | 25.5          | 35.9           |
| M20  | 101           | 33.3               | 67.1          | 23.3             | 67.1          | 19.8          | 63.4           |
|      | 180           | 33.3               | 67.1          | 23.3             | 67.1          | 23.3          | 67.4           |



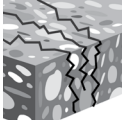

\*with Hilti filling set

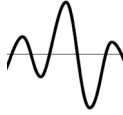
## 4.2. Hilti HST2 V3 Expansion anchor

### High-performance expansion anchor

| Anchor version  |                     | Benefits  |
|---|---------------------|---|
|  | HST2 V3             | <ul style="list-style-type: none"> <li>• Suitable for uncracked and cracked concrete C20/25 to C50/60</li> <li>• Suitable for seismic design with ETA C1/C2 assessment</li> <li>• Longer embedment depth option to get higher resistance, closer distance to the edge or smaller spacing</li> <li>• Shallow embedment depths</li> <li>• Full design flexibility with variable embedment depth and edge &amp; spacing</li> <li>• Faster and reliable installation thanks to approved non-cleaning and adaptive torqueing tool</li> <li>• Product and length identification mark facilitates quality control and inspection</li> <li>• HST2-F suitable for outdoor use with variable working life (e.g. C3 for 25 years)</li> </ul> |
|  | HST2 V3 BW (M8-M16) |   |
|  | HST2- F V3 (M8-M16) |   |
|  | HST2-R V3 (M8-M16)  |   |

| Base material   |   | Load conditions   |  |   |  |
|---|---|---|--|---|--|
|  |  |  |  |  |  |
| Concrete (uncracked)  | Concrete (cracked)  | Static/<br>quasi-static   | Seismic<br>C1/C2   | Fire<br>resistance  |  |

| Drilling, cleaning, setting   |   |   | Other information   |  |  |
|---|---|---|---|--|--|
|  |  |  |  |  |  |
| Hammer drilled holes (with no cleaning)   | Diamond drilled holes   | Impact wrench with adaptive torque module   | PROFIS Engineering software   | Steel to concrete Handbook   |  |

## Linked Approvals/Certificates

### Approvals/certificates

| Approval no                 | Application / loading condition  | Authority / Laboratory | Date of issue |
|-----------------------------|--|------------------------|---------------|
| <a href="#">ETA-21/0480</a> | HST2(-F,-R) V3<br>Static and quasi-static /<br>Seismic / Fire                    | DIBt Berlin            | 31-10-2024    |
| <a href="#">ETA-21/0510</a> | HST2-F V3<br>Variable working life<br>50 years<br>Static and quasi-static / Fire | DIBt Berlin            | 14-11-2024    |

Link to Hilti webpage for more detail information and Instructions for use

| <a href="#">HST2 V3</a>   | <a href="#">HST2-F V3</a>   | <a href="#">HST2-R V3</a>   | <a href="#">HST2 V3 BW</a>  |
|---|---|---|---|
|  |  |  |  |

#### 4.2.1. Minimum concrete slab thickness, edge distance and spacing

ETA-21/0480 [8] provides all the relevant information for the correct setting of the product (Table 4.5 and Table 4.6). Minimum spacing and edge distance values have been shown for concrete thickness of 300 mm in Table 4.5 and Table 4.6 with reference to the definitions given in Fig. 4.1.

Table 4.5: HST2/- F V3: Definitions of minimum concrete thickness, edge distance and spacing

| Uncracked concrete |                    |                |                |                 |                   |                       |                   |
|--------------------|--------------------|----------------|----------------|-----------------|-------------------|-----------------------|-------------------|
|                    | Cleaned drill hole |                |                | Minimum spacing |                   | Minimum edge distance |                   |
| Size               | $h_{ef}$ [mm]      | $h_{nom}$ [mm] | $h_{min}$ [mm] | $s_{min}$ [mm]  | For $c \geq$ [mm] | $c_{min}$ [mm]        | For $s \geq$ [mm] |
| M8                 | 30                 | 40             | 100            | 40              | 55                | 45                    | 65                |
|                    | 70                 | 80             | 110            | 40              | 50                | 45                    | 50                |
| M10                | 40                 | 50             | 120            | 55              | 75                | 55                    | 105               |
|                    | 80                 | 90             | 125            | 55              | 70                | 55                    | 95                |
| M12                | 50                 | 63             | 140            | 60              | 75                | 55                    | 125               |
|                    | 100                | 113            | 155            | 60              | 65                | 55                    | 115               |
| M16                | 65                 | 78             | 160            | 70              | 85                | 70                    | 105               |
|                    | 120                | 133            | 180            | 70              | 75                | 70                    | 95                |



| Cracked concrete |                    |                |                |                 |                   |                       |                   |
|------------------|--------------------|----------------|----------------|-----------------|-------------------|-----------------------|-------------------|
|                  | Cleaned drill hole |                |                | Minimum spacing |                   | Minimum edge distance |                   |
| Size             | $h_{ef}$ [mm]      | $h_{nom}$ [mm] | $h_{min}$ [mm] | $s_{min}$ [mm]  | For $c \geq$ [mm] | $c_{min}$ [mm]        | For $s \geq$ [mm] |
| M8               | 30                 | 40             | 100            | 40              | 50                | 45                    | 40                |
|                  | 70                 | 80             | 110            | 40              | 45                | 45                    | 40                |
| M10              | 40                 | 50             | 120            | 55              | 55                | 55                    | 55                |
|                  | 80                 | 90             | 125            | 55              | 55                | 55                    | 55                |
| M12              | 50                 | 63             | 140            | 60              | 60                | 55                    | 70                |
|                  | 100                | 113            | 155            | 60              | 60                | 55                    | 60                |
| M16              | 65                 | 78             | 160            | 70              | 70                | 70                    | 70                |
|                  | 120                | 133            | 180            | 70              | 70                | 70                    | 70                |

**Note:** The minimum spacing and edge distance depend on the effective embedment depth, minimum concrete slab thickness and actual slab thickness. All values are provided for cleaned borehole. Please refer to ETA-21/0480 for all other conditions.

Table 4.6: HST2 R V3: Definitions of minimum concrete thickness, edge distance and spacing

| Uncracked concrete |                    |                |                |                 |                   |                       |                   |
|--------------------|--------------------|----------------|----------------|-----------------|-------------------|-----------------------|-------------------|
|                    | Cleaned drill hole |                |                | Minimum spacing |                   | Minimum edge distance |                   |
| Size               | $h_{ef}$ [mm]      | $h_{nom}$ [mm] | $h_{min}$ [mm] | $s_{min}$ [mm]  | For $c \geq$ [mm] | $c_{min}$ [mm]        | For $s \geq$ [mm] |
| M8                 | 30                 | 38             | 100            | 40              | 60                | 45                    | 90                |
|                    | 70                 | 78             | 105            | 40              | 60                | 45                    | 80                |
| M10                | 40                 | 49             | 120            | 55              | 70                | 50                    | 130               |
|                    | 80                 | 89             | 125            | 55              | 70                | 50                    | 115               |
| M12                | 50                 | 60             | 140            | 60              | 80                | 55                    | 155               |
|                    | 100                | 110            | 150            | 60              | 75                | 55                    | 155               |
| M16                | 65                 | 78             | 160            | 70              | 100               | 60                    | 200               |
|                    | 120                | 133            | 180            | 70              | 85                | 60                    | 210               |

| Cracked concrete |                    |                |                |                 |                   |                       |                   |
|------------------|--------------------|----------------|----------------|-----------------|-------------------|-----------------------|-------------------|
|                  | Cleaned drill hole |                |                | Minimum spacing |                   | Minimum edge distance |                   |
| Size             | $h_{ef}$ [mm]      | $h_{nom}$ [mm] | $h_{min}$ [mm] | $s_{min}$ [mm]  | For $c \geq$ [mm] | $c_{min}$ [mm]        | For $s \geq$ [mm] |
| M8               | 30                 | 38             | 100            | 40              | 50                | 45                    | 50                |
|                  | 70                 | 78             | 105            | 40              | 50                | 45                    | 45                |
| M10              | 40                 | 49             | 120            | 55              | 65                | 50                    | 100               |
|                  | 80                 | 89             | 125            | 55              | 65                | 50                    | 90                |
| M12              | 50                 | 60             | 140            | 60              | 70                | 55                    | 110               |
|                  | 100                | 110            | 150            | 60              | 65                | 55                    | 110               |
| M16              | 65                 | 78             | 160            | 70              | 80                | 60                    | 135               |
|                  | 120                | 133            | 180            | 70              | 75                | 60                    | 145               |

**Note:** The minimum spacing and edge distance depend on the effective embedment depth, minimum concrete slab thickness and actual slab thickness. All values are provided for cleaned borehole. Please refer to ETA-21/0480 for all other conditions.

#### 4.2.2. Static, quasi-static and Seismic C2 anchor design resistance

EN 1992-4 [2] provides formulae for the calculation of the design resistance considering edge distance and spacing for each anchor layout configuration according to the performance data indicated in the relevant ETA-21/0480 [8]. All data in this section (Table 4.7 and Table 4.8) apply to:

- Correct setting (please refer to setting details in the anchor Instructions for Use)
- Single anchor, with no edge distance and spacing influence
- Minimum base material thickness
- Concrete grade C20/25
- Hammer drilled holes (M8 to M16)

Table 4.7: HST2/-F V3 and HST2-R V3: Design resistance against static loading

| Concrete | Size          | HST2/-F V3         |               |                  |               | HST2-R V3          |               |                  |                |
|----------|---------------|--------------------|---------------|------------------|---------------|--------------------|---------------|------------------|----------------|
|          |               | Uncracked concrete |               | Cracked concrete |               | Uncracked concrete |               | Cracked concrete |                |
|          | $h_{ef}$ [mm] | $N_{Rd}$ [kN]      | $V_{Rd}$ [kN] | $N_{Rd}$ [kN]    | $V_{Rd}$ [kN] | $N_{Rd}$ [kN]      | $V_{Rd}$ [kN] | $N_{Rd}$ [kN]    | $V_{Rd}$ [kN]* |
| M8       | 30            | 5.4                | 8.5           | 3.3              | 8.5           | 5.4                | 12.6          | 3.3              | 8.8            |
|          | 70            | 10.7               | 8.5           | 4.7              | 8.5           | 10.7               | 12.6          | 3.3              | 12.6           |
| M10      | 40            | 8.3                | 15.1          | 5.8              | 14.8          | 8.3                | 20.2          | 5.8              | 14.8           |
|          | 80            | 16.0               | 15.1          | 7.3              | 15.1          | 16.7               | 20.2          | 6.0              | 20.2           |
| M12      | 50            | 11.6               | 23.6          | 8.1              | 20.9          | 11.6               | 29.4          | 8.0              | 20.9           |
|          | 100           | 22.7               | 23.6          | 9.3              | 23.6          | 23.3               | 29.4          | 8.0              | 29.4           |
| M16      | 65            | 17.2               | 40.8          | 12               | 33.9          | 17.2               | 48.5          | 12               | 33.9           |
|          | 120           | 29.3               | 40.8          | 16.7             | 40.8          | 30.7               | 50.9          | 16.7             | 50.9           |

\*with Hilti filling set

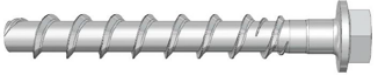

Table 4.8: HST2/-F and HST2-R V3: Design resistance against seismic C2





| Concrete | Size          | HST2/-F          |               | HST2-R           |                |
|----------|---------------|------------------|---------------|------------------|----------------|
|          |               | Cracked concrete |               | Cracked concrete |                |
|          | $h_{ef}$ [mm] | $N_{Rd}$ [kN]    | $V_{Rd}$ [kN] | $N_{Rd}$ [kN]    | $V_{Rd}$ [kN]* |
| M10      | 60            | 3.7              | 5.9           | 2.2              | 9.6            |
| M12      | 70            | 9.3              | 8.9           | 6.7              | 14.4           |
| M16      | 85            | 12.0             | 20.0          | 8.5              | 30.0           |





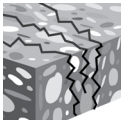
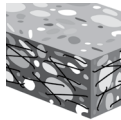

\*with Hilti filling set

### 4.3. Hilti HUS4 Screw anchor for use in concrete

#### High performance screw anchor for single point fastening

| Anchor version  |                      | Benefits   |
|---|----------------------|--|
|  | HUS4-H(F)<br>(8-16)  | <ul style="list-style-type: none"> <li>• High productivity - less drilling and fewer operations than with conventional anchors</li> <li>• ETA for cracked and uncracked concrete</li> <li>• ETA approval for Seismic C1 and C2</li> </ul>                                    |
|  | HUS4-C<br>(8-10)     | <ul style="list-style-type: none"> <li>• ETA approval for adjustability (unscrew-rescrew)</li> <li>• Smaller edge and spacing distance</li> <li>• Three embedment depths for maximum design flexibility and flexible design for concrete cone capacity</li> </ul>            |
|  | HUS4-A(F)<br>(10-14) | <ul style="list-style-type: none"> <li>• No cleaning required for size 8 to 14</li> <li>• HUS4-HF and HUS4-AF with multilayer coatings for additional corrosion protection</li> <li>• Through fastening with H, A and C head</li> <li>• Pre-fastening with A head</li> </ul> |

| Base material   |   |   | Load conditions   |  |   |  |
|---|---|---|---|--|---|--|
|  |  |  |  |  |  |  |
| Concrete (uncracked)  | Concrete (cracked)  | Steel fibre reinforced concrete   | Static/<br>quasi-static   | Seismic C1/C2  | Fire resistance   |  |

| Drilling, cleaning, setting   |   |   | Other information   |   |  |
|---|---|---|---|---|--|
|  |  |  |  |  |  |
| Hammer drilled holes  | Diamond drilled holes   | Hollow drill-bit drilling   | Impact wrench with adaptative torque module   | PROFIS Engineering software   | Steel to concrete Handbook   |

**Linked Approvals/Certificates**

| Approval no                 | Application / loading condition         | Authority / Laboratory | Date of issue |
|-----------------------------|---|------------------------|---------------|
| <a href="#">ETA-20/0867</a> | Static and quasi-static / Seismic/ Fire | DIBt Berlin            | 11-02-2025    |

HUS4 16 in general and adjustability of HUS4 8 and 10 for SFRC are not in the scope of the ETA.

**Link to Hilti webpage for more detail information and Instructions for use**

| <a href="#">HUS4-H</a>  | <a href="#">HUS4-HF</a>   | <a href="#">HUS4-C</a>  | <a href="#">HUS4-A</a>  | <a href="#">HUS4-AF</a>  |
|---|---|---|---|--|
|  |  |  |  |  |

**4.3.1. Minimum concrete slab thickness, edge distance and spacing**

ETA-20/0867 [9] provides all the relevant information for the correct setting of the product. Table 4.9 and Table 4.10 provide the values of minimum edge distance, spacing and concrete thickness for HUS4 and HUS4-R anchors with reference to the definitions given in Fig. 4.1.

Table 4.9: HUS4: Definitions of minimum concrete thickness, edge distance and spacing

| Uncracked and cracked concrete |               |                |                |                |                |
|--------------------------------|---------------|----------------|----------------|----------------|----------------|
| Size                           | $h_{ef}$ [mm] | $h_{nom}$ [mm] | $h_{min}$ [mm] | $s_{min}$ [mm] | $c_{min}$ [mm] |
| <b>8</b><br>(H, HF, C)         | 30.6          | 40             | 80             | 35             | 35             |
|                                | 47.6          | 60             | 100            | 35             | 35             |
|                                | 56.1          | 70             | 120            | 35             | 35             |
| <b>10</b><br>(H, HF, C, A, AF) | 42.5          | 55             | 100            | 40             | 40             |
|                                | 59.5          | 75             | 130            | 40             | 40             |
|                                | 68.0          | 85             | 140            | 40             | 40             |
| <b>12</b><br>(H)               | 45.9          | 60             | 110            | 50             | 50             |
|                                | 62.9          | 80             | 130            | 50             | 50             |
|                                | 79.9          | 100            | 150            | 50             | 50             |
| <b>14</b><br>(H, HF, A, AF)    | 49.3          | 65             | 120            | 60             | 60             |
|                                | 66.3          | 85             | 160            | 60             | 60             |
|                                | 91.8          | 115            | 200            | 60             | 60             |
| <b>16</b><br>H, HF             | 66.6          | 85             | 130            | 90             | 65             |
|                                | 104.9         | 130            | 195            | 90             | 65             |

Table 4.10: HUS4-R: Definitions of minimum concrete thickness, edge distance and spacing

| Uncracked and cracked concrete |               |                |                |                |                |
|--------------------------------|---------------|----------------|----------------|----------------|----------------|
| Size                           | $h_{ef}$ [mm] | $h_{nom}$ [mm] | $h_{min}$ [mm] | $s_{min}$ [mm] | $c_{min}$ [mm] |
| 8<br>(HR, CR)                  | 47.0          | 60             | 100            | 45             | 45             |
|                                | 64.0          | 80             | 120            | 50             | 50             |
| 10<br>(HR, CR)                 | 54.0          | 70             | 120            | 50             | 50             |
|                                | 71.0          | 90             | 140            | 50             | 50             |
| 14<br>(HR)                     | 52.0          | 70             | 140            | 50             | 50             |
|                                | 86.0          | 110            | 160            | 60             | 60             |

### 4.3.2. Static, quasi-static and seismic C1 anchor design resistance

EN 1992-4 [2] provides formulae for the calculation of the design resistance considering edge distance and spacing for each anchor layout configuration according to the performance data indicated in the relevant ETA-20/0867 [9]. All data in this section (Table 4.11 and Table 4.12) applies to:

- Correct setting (please refer to setting details in the anchor Instructions for Use)
- Single anchor, with no edge distance and spacing influence
- Minimum base material thickness
- Concrete grade C20/25 with and without steel fibers
- Hammer drilled holes (sizes 8 to 16).

Table 4.11: HUS4: Design resistance at minimum and maximum effective embedment depth

| Size                    | $h_{ef}$ [mm] | Uncracked concrete |               | Cracked concrete |               | Seismic C2    |                |
|-------------------------|---------------|--------------------|---------------|------------------|---------------|---------------|----------------|
|                         |               | $N_{Rd}$ [kN]      | $V_{Rd}$ [kN] | $N_{Rd}$ [kN]    | $V_{Rd}$ [kN] | $N_{Rd}$ [kN] | $V_{Rd}$ [kN]* |
| 8<br>(H, HF, C)         | 30.6          | 5.6                | 5.6           | 3.7              | 3.9           | -             | -              |
|                         | 47.6          | 10.8               | 15.0          | 7.5              | 15.0          | -             | -              |
|                         | 56.1          | 13.8               | 17.5          | 9.6              | 17.5          | 1.8           | 4.3            |
| 10<br>(H, HF, C, A, AF) | 42.5          | 7.2                | 9.1           | 5.3              | 6.4           | 1.7           | 4.3            |
|                         | 59.5          | 14.7               | 23.0          | 10.5             | 21.1          | 2.4           | 4.3            |
|                         | 68.0          | 18.4               | 25.6          | 12.9             | 25.6          | 3.6           | 5.9            |
| 12<br>(H)               | 45.9          | 10.2               | 20.4          | 6.7              | 14.3          | -             | -              |
|                         | 62.9          | 16.4               | 31.1          | 11.5             | 22.9          | -             | -              |
|                         | 79.9          | 23.4               | 35.9          | 16.4             | 32.8          | 7.6           | 9.5            |
| 14<br>(H, HF, A, AF)    | 49.3          | 11.4               | 22.7          | 7.9              | 15.9          | -             | -              |
|                         | 66.3          | 17.7               | 35.4          | 12.4             | 24.8          | -             | -              |
|                         | 91.8          | 28.8               | 49.6          | 20.2             | 40.4          | 11.8          | 13.8           |
| 16<br>H, HF             | 66.6          | 14.7               | 35.6          | 10.7             | 25.0          | -             | -              |
|                         | 104.9         | 30.7               | 58.5          | 21.3             | 49.3          | -             | -              |

\*with Hilti filling set

Table 4.12: HUS4-R: Design resistance at minimum and maximum effective embedment depth

| Size           | $h_{ef}$ [mm] | Uncracked concrete |               | Cracked concrete |               | Seismic C1    |                |
|----------------|---------------|--------------------|---------------|------------------|---------------|---------------|----------------|
|                |               | $N_{Rd}$ [kN]      | $V_{Rd}$ [kN] | $N_{Rd}$ [kN]    | $V_{Rd}$ [kN] | $N_{Rd}$ [kN] | $V_{Rd}$ [kN]* |
| 8<br>(HR, CR)  | 47.0          | 8.0                | 17.3          | 5.7              | 14.8          | -             | -              |
|                | 64.0          | 8.9                | 17.3          | 8.3              | 17.3          | 4.3           | 7.4            |
| 10<br>(HR, CR) | 54.0          | 8.9                | 22.0          | 6.7              | 18.2          | -             | -              |
|                | 71.0          | 16.7               | 22.0          | 10.7             | 22.0          | 8.3           | 11.9           |
| 14<br>(HR)     | 52.0          | 10.2               | 24.6          | 6.7              | 17.2          | -             | -              |
|                | 86.0          | 21.8               | 51.3          | 13.9             | 36.6          | 9.7           | 31.1           |





Seismic C1 resistance values are valid for HUS4-HR version. only.

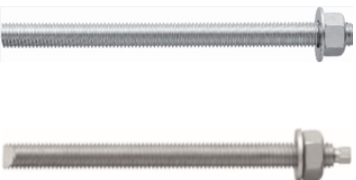



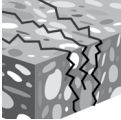
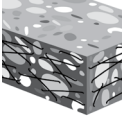

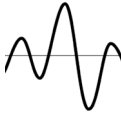
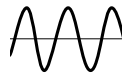
#### 4.4. Hilti HIT-HY200-A V3 and -R V3 injection mortars with HAS U rods

Anchor design (EN 1992-4, EOTA TR 082) / Rods, Sleeves and Rebar / Concrete

| Injection mortar system   | Benefits   |
|---|--|
|  <p>Hilti HIT-HY 200-A V3<br/>Hilti HIT-HY 200-R V3</p>   | <ul style="list-style-type: none"> <li>• Automatic borehole cleaning with hollow drill bits, accurate dosing with HDE and fast and safe torquing with the adaptive torque (AT) system.</li> <li>• Suitable for uncracked and cracked concrete C20/25 to C50/60</li> <li>• ETA Approved for seismic performance category C1, C2</li> <li>• Maximum load performance in cracked concrete and uncracked concrete</li> <li>• High corrosion / corrosion resistance</li> <li>• Small edge distance and anchor spacing possible</li> <li>• Manual cleaning for borehole diameter up to 20mm and <math>h_{ef} \leq 10d</math> for uncracked concrete only</li> <li>• ETA data for 50 and 100 Years Working Life</li> <li>• Suitable for dry and water saturated concrete</li> <li>• Data under fire exposure in accordance with EOTA TR 082 for threaded rod size M8 to M30</li> <li>• Anchorage in steel fibre-reinforced concrete with HAS-D</li> </ul> |
|  <p>500 ml foil pack (also available as 330 ml foil pack)</p>  |  |
|  <p>Anchor rod (M8-M30):<br/>HAS,<br/>HAS HDG,<br/>HAS A4,<br/>HAS-U,<br/>HAS-U HDG,<br/>HAS-U A4,<br/>HAS-U HCR</p> |  |
|  <p>Internally threaded sleeve (M8-M20):<br/>HIS-N<br/>HIS-RN</p>  |  |
|  <p>Anchor rod (M8-M20):<br/>HIT-Z(-D) TP<br/>HIT-Z-F<br/>HIT-Z-R(-D) TP</p>   |  |
|  <p>Anchor rod (M12-M20):<br/>HAS-D</p>  |  |
|  <p>Rebar (φ8 - φ32)</p>   |  |

Application condition

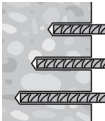
| Base material   |   |   | Load conditions   |   |   |  |
|---|---|---|---|---|---|--|
|  |  |  |  |  |  |  |
| Concrete (uncracked)  | Concrete (cracked)  | Steel fibre reinforced concrete   | Static/ quasi-static  | Seismic C1, C2  | Fatigue   | Fire resistance  |

| Drilling, cleaning, setting   |   |   |   | Other information   |                            |  |   |
|---|---|---|---|---|----------------------------|--|---|
|  |  |  |  |  | <b>100 YEARS</b>           |  |  |
| Hammer drilled holes  | Diamond drilled holes   | Hollow Drill Bit drilled holes  | Water-filled borehole in concrete   | Variable embedment depth  | ETA 100 Years Working Life | PROFIS Engineering Software  | Steel to concrete Handbook  |

Linked Approvals/Certificates

Approvals/certificates

| Approval no  | Application / loading condition             | Authority / Laboratory | Date of issue |
|--|---|------------------------|---------------|
| <a href="#">ETA-19/0601</a><br>(HAS, HIS-N, rebar) | Static and quasi-static / Seismic / Fire    | DIBt, Berlin           | 29-01-2024    |
| <a href="#">ETA-19/0632</a><br>(HIT-Z)             | Static and quasi-static / Seismic           | DIBt, Berlin           | 26-09-2024    |
| <a href="#">ETA-18/0972</a><br>(HAS-D)             | Static and quasi-static                     | DIBt, Berlin           | 26-09-2024    |
| <a href="#">ETA-15/0296</a><br>(HIT-Z-D-TP)        | Static and quasi-static / Seismic           | DIBt, Berlin           | 18-07-2023    |
| <a href="#">ETA-18/0978</a><br>(HAS-D)             | Static and quasi-static / Fatigue           | DIBt, Berlin           | 26-09-2024    |
| <a href="#">ETA-19/0802</a><br>(HIT-Z-D-TP)        | Static and quasi-static / Fatigue           | DIBt, Berlin           | 18-09-2024    |
| No.: 01/2024<br>(HAS, HIS-N, rebar)                | 120-years working life based on ETA-19/0601 | BERGMEISTER, Vienna    | 18-03-2024    |

Link to Hilti webpage for more detail information and Instructions for use

| Injection mortars / Dispenser / Accessories                                       |   |   |   |  |   |
|---|---|---|---|--|---|
| <a href="#">HIT-HY 200-A V3</a>   | <a href="#">HIT-HY 200-R V3</a>   | <a href="#">HDE 500-22</a>  | <a href="#">HDE 500-A12</a>   | <a href="#">HDM 500</a>  | <a href="#">Filling set</a>   |
|  |  |  |  |  |  |
| Fastener: Threaded rod  |   |   |   |  |   |
| <a href="#">HAS-U 8.8</a>   | <a href="#">HAS 8.8</a>   | <a href="#">HIS-N</a>   | <a href="#">HIT-Z</a>   | <a href="#">HIT-Z-D-TP</a>   | <a href="#">HAS-D</a>   |
|  |  |  |  |  |  |

#### 4.4.1. Minimum concrete slab thickness, edge distance and spacing

ETA-19/0601 [10] provides all the relevant information for the correct setting of the product (Table 4.13). Minimum concrete slab thickness is shown in the table is for minimum and maximum embedment depth with reference to the definitions given in Fig. 4.1.

Table 4.13: HIT-HY 200-A V3 and HIT-HY 200-R V3 with HAS U rods: Minimum concrete slab thickness

| Uncracked and cracked concrete |               |                |                |                |                |
|--------------------------------|---------------|----------------|----------------|----------------|----------------|
| Size                           | $h_{ef}$ [mm] | $h_{nom}$ [mm] | $h_{min}$ [mm] | $s_{min}$ [mm] | $c_{min}$ [mm] |
| M8                             | 60            | 60             | 100            | 40             | 40             |
|                                | 160           | 160            | 190            | 40             | 40             |
| M10                            | 60            | 60             | 100            | 50             | 45             |
|                                | 200           | 200            | 230            | 50             | 45             |
| M12                            | 70            | 70             | 100            | 60             | 45             |
|                                | 240           | 240            | 270            | 60             | 45             |
| M16                            | 80            | 80             | 116            | 75             | 50             |
|                                | 320           | 320            | 356            | 75             | 50             |
| M20                            | 90            | 90             | 134            | 90             | 55             |
|                                | 400           | 400            | 444            | 90             | 55             |
| M24                            | 96            | 96             | 152            | 115            | 60             |
|                                | 480           | 480            | 536            | 115            | 60             |
| M27                            | 108           | 108            | 168            | 120            | 75             |
|                                | 540           | 540            | 600            | 120            | 75             |
| M30                            | 120           | 120            | 190            | 140            | 80             |
|                                | 600           | 600            | 670            | 140            | 80             |



#### 4.4.2. Static, quasi-static and Seismic C2 anchor design resistance

EN 1992-4 [2] provides formulae for the calculation of the design resistance considering edge distance and spacing for each anchor layout configuration according to the performance data indicated in the relevant ETA-19/0601 [10]. All data in this section (Table 4.14 and Table 4.15) apply to:

- Correct setting (please refer to setting details in the anchor Instructions for Use)
- Single anchor, with no edge distance and spacing influence
- Minimum base material thickness
- Concrete grade C20/25
- Hammer drilled and diamond cored holes (M8 to M30), hammer drilled holes with Hilti hollow drill bit (M8-M30)
- Reference embedment depths as specified in the table
- In-service temperature range I (min. base material temperature: -40°C, max long term/short term base material temperature: +24°C/+40°C)
- $\psi_{sus} = 1.0$ . For specific design cases involving smaller percentages of permanent loads, please refer to PROFIS Engineering

Table 4.14: HAS-U 5.8 rods: Design resistance at one selected embedment depth

| Size | $h_{ef}$ [mm] | Uncracked concrete |               | Cracked concrete |               | Seismic C2    |                |
|------|---------------|--------------------|---------------|------------------|---------------|---------------|----------------|
|      |               | $N_{Rd}$ [kN]      | $V_{Rd}$ [kN] | $N_{Rd}$ [kN]    | $V_{Rd}$ [kN] | $N_{Rd}$ [kN] | $V_{Rd}$ [kN]* |
| M8   | 80            | 12.2               | 8.8           | 10.0             | 8.8           | -             | -              |
| M10  | 90            | 19.3               | 13.9          | 17.7             | 13.9          | -             | -              |
| M12  | 110           | 28.1               | 20.2          | 26.3             | 20.2          | -             | -              |
| M16  | 125           | 45.8               | 37.7          | 32.1             | 37.7          | -             | -              |
| M20  | 170           | 72.7               | 58.8          | 50.9             | 58.8          | -             | -              |
| M24  | 210           | 99.8               | 84.7          | 69.9             | 84.7          | -             | -              |
| M27  | 240           | 121.9              | 110.2         | 85.4             | 110.2         | -             | -              |
| M30  | 270           | 145.5              | 134.6         | 101.8            | 134.6         | -             | -              |



Table 4.15: HAS-U 8.8 rods: Design resistance at one selected embedment depth





| Size | $h_{ef}$ [mm] | Uncracked concrete |               | Cracked concrete |               | Seismic C2    |                |
|------|---------------|--------------------|---------------|------------------|---------------|---------------|----------------|
|      |               | $N_{Rd}$ [kN]      | $V_{Rd}$ [kN] | $N_{Rd}$ [kN]    | $V_{Rd}$ [kN] | $N_{Rd}$ [kN] | $V_{Rd}$ [kN]* |
| M8   | 80            | 19.5               | 11.7          | 10.0             | 11.7          | -             | -              |
| M10  | 90            | 28.0               | 18.6          | 17.7             | 18.6          | -             | -              |
| M12  | 110           | 37.8               | 27.0          | 26.3             | 27.0          | 7.5           | 22.4           |
| M16  | 125           | 45.8               | 50.2          | 32.1             | 50.2          | 19.3          | 36.8           |
| M20  | 170           | 72.7               | 78.4          | 50.9             | 78.4          | 32.8          | 61.6           |
| M24  | 210           | 99.8               | 113.0         | 69.9             | 113.0         | 36.9          | 82.4           |
| M27  | 240           | 121.9              | 146.9         | 85.4             | 146.9         | -             | -              |
| M30  | 270           | 145.5              | 179.5         | 101.8            | 179.5         | -             | -              |



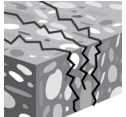

\*with Hilti filling set

## 4.5. Hilti HVU2 adhesive capsule with HAS U rods

### Anchor design (EN 1992-4) / Rods and Sleeves / Concrete

| Anchor version  |  | Benefits  |
|---|--|---|
|  | HVU2 Adhesive capsule  | <ul style="list-style-type: none"> <li>Hilti hollow drill bit for automatic cleaning</li> <li>Suitable for cracked and uncracked concrete C20/25 to C50/60 both for hammer drilled and diamond cored holes</li> </ul>   |
|  | Anchor rod<br>M8-M30:<br>HAS-U<br>HAS-U HDG<br>HAS-U A4<br>HAS-U HCR<br>Including P versions | <ul style="list-style-type: none"> <li>Highly reliable and safe anchor for seismic design with ETA C1/C2 approval. Seismic C1 ETA available even for diamond cored holes.</li> <li>Clean and fast installation that suits hard jobsite conditions</li> <li>Suitable for dry and water saturated concrete</li> </ul> |
|  | Internally threaded sleeve<br>M8-M20:<br>HIS-N<br>HIS-RN                                     | <ul style="list-style-type: none"> <li>High loading capacity</li> <li>Short curing time</li> <li>In service temperature range up to 120°C short term / 72°C long term</li> </ul>  |

| Base material   |   | Load conditions   |   |  |   |  |
|---|---|---|---|--|---|--|
|  |  |  |  |  |  |  |
| Concrete (uncracked)  | Concrete (cracked)  | Static/<br>quasi-static   | Seismic<br>C1/C2  | Fatigue  | Fire<br>resistance  |  |



| Drilling, cleaning, setting   |   |   | Other information   |   |
|---|---|---|---|---|
|  |  |  |  |  |
| Hammer drilled holes  | Hollow Drill Bit drilled holes  | Diamond cored holes   | PROFIS Engineering software   | Steel to concrete Handbook  |

Linked Approvals/Certificates

Approvals/certificates

| Approval no                 | Application / loading condition          | Authority / Laboratory | Date of issue |
|-----------------------------|--|------------------------|---------------|
| <a href="#">ETA-16/0515</a> | Static and quasi-static / Seismic / Fire | DIBt, Berlin           | 14-09-2023    |

Link to Hilti webpage for more detail information and Instructions for use

| Capsule /Accessories/Fastener   |   |   |   |
|---|---|---|---|
| <a href="#">HVU2</a>  | <a href="#">Filling set</a>   | <a href="#">HAS-U</a>   | <a href="#">HIS-N</a>   |
|  |  |  |  |

4.5.1. Minimum concrete slab thickness, edge distance and spacing

ETA-16/0515 [11] provides all the relevant information for correct setting of the product in terms of minimum edge distances and spacings (Table 4.16). Minimum concrete slab thickness shown in the table is for minimum and maximum embedment depth with reference to the definitions given in Fig. 4.1.

Table 4.16: HVU2 with HAS U rods: Minimum concrete slab thickness, spacing and edge distance

| Uncracked and cracked concrete |               |                |                |                |                |
|--------------------------------|---------------|----------------|----------------|----------------|----------------|
| Size                           | $h_{ef}$ [mm] | $h_{nom}$ [mm] | $h_{min}$ [mm] | $s_{min}$ [mm] | $c_{min}$ [mm] |
| <b>M8</b>                      | 80            | 80             | 110            | 40             | 40             |
| <b>M10</b>                     | 90            | 90             | 120            | 50             | 45             |
|                                | 135           | 135            | 165            | 50             | 45             |
| <b>M12</b>                     | 110           | 110            | 140            | 60             | 45             |
|                                | 165           | 165            | 195            | 60             | 45             |
| <b>M16</b>                     | 125           | 125            | 160            | 75             | 50             |
|                                | 190           | 190            | 230            | 75             | 50             |
| <b>M20</b>                     | 170           | 170            | 220            | 90             | 55             |
| <b>M24</b>                     | 210           | 210            | 270            | 115            | 60             |
| <b>M27</b>                     | 240           | 240            | 300            | 120            | 75             |
| <b>M30</b>                     | 270           | 270            | 340            | 140            | 80             |

#### 4.5.2. Static, quasi-static and Seismic C2 anchor design resistance

EN 1992-4 [2] provides formulae for the calculation of the design resistance considering edge distance and spacing for each anchor layout configuration according to the performance data indicated in the relevant ETA-16/0515 [11]. All data in this section (Table 4.17 and Table 4.18) apply to:

- Correct setting (please refer to setting details in the anchor Instructions for Use)
- Single anchor, with no edge distance and spacing influence
- Minimum base material thickness
- Concrete grade C20/25
- Hammer drilled holes (M8 to M30), hammer drilled holes with Hilti hollow drill bit (M8-M30)
- Reference embedment depths as specified in the table
- In-service temperature range I (min. base material temperature: -40°C, max long term/short term base material temperature: +24°C/+40°C)
- $\psi_{sus} = 1.0$ . For specific design cases involving smaller percentages of permanent loads, please refer to PROFIS Engineering

Table 4.17: HAS-U 5.8 rods: Design resistance at one selected embedment depth

| Size | $h_{ef}$ [mm] | Uncracked concrete |               | Cracked concrete |               | Seismic C2    |                |
|------|---------------|--------------------|---------------|------------------|---------------|---------------|----------------|
|      |               | $N_{Rd}$ [kN]      | $V_{Rd}$ [kN] | $N_{Rd}$ [kN]    | $V_{Rd}$ [kN] | $N_{Rd}$ [kN] | $V_{Rd}$ [kN]* |
| M8   | 80            | 12.2               | 7.3           | 6.7              | 7.3           | -             | -              |
| M10  | 90            | 19.3               | 11.6          | 16.0             | 11.6          | -             | -              |
|      | 135           | 19.3               | 11.6          | 19.3             | 11.6          | -             | -              |
| M12  | 110           | 28.1               | 16.9          | 23.5             | 16.9          | -             | -              |
|      | 165           | 28.1               | 16.9          | 28.1             | 16.9          | -             | -              |
| M16  | 125           | 45.8               | 31.4          | 32.1             | 31.4          | -             | -              |
|      | 190           | 52.3               | 31.4          | 52.3             | 31.4          | -             | -              |
| M20  | 170           | 72.7               | 49.0          | 50.9             | 49.0          | -             | -              |
| M24  | 210           | 99.8               | 70.6          | 69.9             | 70.6          | -             | -              |
| M27  | 240           | -                  | -             | -                | -             | -             | -              |
| M30  | 270           | -                  | -             | -                | -             | -             | -              |

Table 4.18: HAS-U 8.8 rods: Design resistance at one selected embedment depth

| Size | $h_{ef}$ [mm] | Uncracked concrete |               | Cracked concrete |               | Seismic C2    |                |
|------|---------------|--------------------|---------------|------------------|---------------|---------------|----------------|
|      |               | $N_{Rd}$ [kN]      | $V_{Rd}$ [kN] | $N_{Rd}$ [kN]    | $V_{Rd}$ [kN] | $N_{Rd}$ [kN] | $V_{Rd}$ [kN]* |
| M8   | 80            | 16.1               | 11.7          | 6.7              | 11.7          | -             | -              |
| M10  | 90            | 28.0               | 18.6          | 16.0             | 18.6          | -             | -              |
|      | 135           | 30.9               | 18.6          | 24.0             | 18.6          | -             | -              |
| M12  | 110           | 37.8               | 27.0          | 23.5             | 27.0          | -             | -              |
|      | 165           | 45.0               | 27.0          | 35.2             | 27.0          | -             | -              |
| M16  | 125           | 45.8               | 50.2          | 32.1             | 50.2          | 12.1          | 32             |
|      | 190           | 83.9               | 50.2          | 54.1             | 50.2          | 18.5          | 32             |
| M20  | 170           | 72.7               | 78.4          | 50.9             | 78.4          | 18.5          | 56.8           |
| M24  | 210           | 99.8               | 113.0         | 69.9             | 113.0         | -             | -              |
| M27  | 240           | 121.9              | 146.9         | 85.4             | 146.9         | -             | -              |
| M30  | 270           | 145.5              | 179.5         | 102              | 179.5         | -             | -              |

\*with Hilti filling set

## 5. Design examples

This chapter of the handbook aims at providing comprehensive design examples, serving as a general reference in the design of post-installed anchors in timber-to-concrete connections. The examples refer to some typical applications already outlined in the previous chapters. Each example shows the design equations and calculations, according to EN 1992-4 [2] provisions, for relevant load conditions and failure modes. An exhaustive description of every design requirement indicated in the EN 1992-4 [2] falls beyond the scope of this handbook. This section nevertheless aims to support structural engineers who may lack familiarity with anchors or seek to validate their design approaches according to the latest international standards.

As a short overview of the key aspects in designing post-installed anchors, it is worth recognizing that, as for other structural elements, the design process must ensure conformity to the requirements of serviceability and ultimate limit states. At **serviceability limit state**, fasteners must exhibit limited deformations to ensure the structure's functionality. At the **ultimate limit state**, fasteners must withstand all actions occurring during the structure execution and use. Additionally, anchor materials and **corrosion protection** should be selected based on environmental exposure and any other external factors negatively affecting the fastener **service life**, for the fastening point to remain fit for use for the whole operational lifespan of the application (usually considered as 50 years).

The actions on the fixture are determined according to the same principles that are valid for other structural elements and described in EN 1990 [12], EN 1991 [13] and EN 1998 [14]. EN 1992-4 [2] details the durability criteria, the methodology to determine forces on the anchors and how to verify all failure modes. Provisions include a range of load scenarios such as static loads, seismic loads, as well as fire exposure.

**Note:** Some post-installed anchors are also designed for design service life of >100 years (refer to Hilti online or FTM [5]).

EN 1992-4 [2] addresses fastening configurations (Fig. 5.1 and Fig. 5.2) with standard geometries, which cover the most common timber-to-concrete applications.

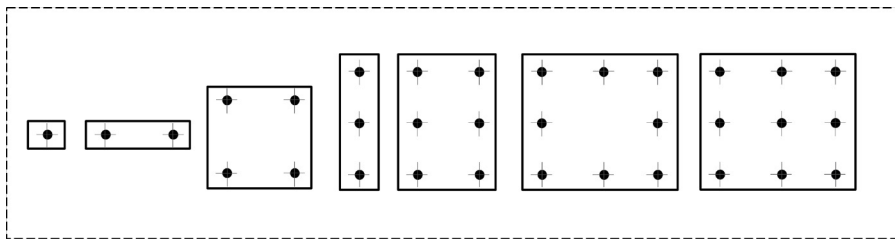

Fig. 5.1: Fastening without hole clearance for all edge distances - by EN 1992-4 covered configurations

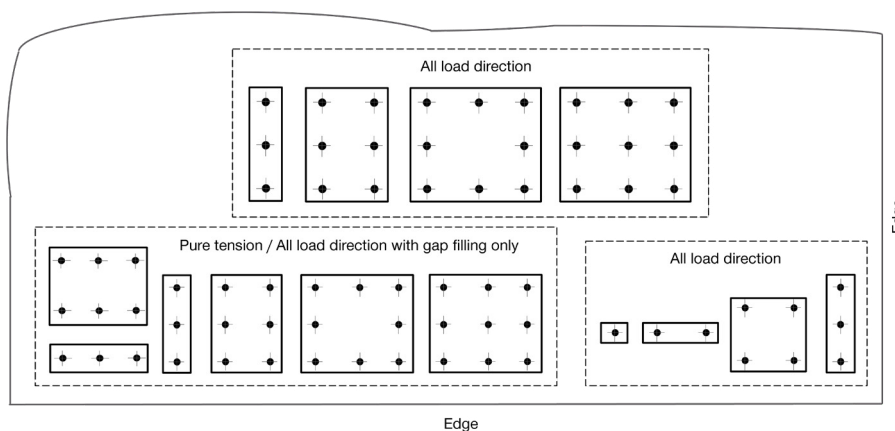

Fig. 5.2: Fastening with hole clearances situated near to edge - by EN 1992-4 covered configurations

EN 1992-4 [2] assumes rigid fixtures, and that the load distribution on the fasteners can be determined on the base of elastic analysis. Under such assumptions:

- The distribution of strains across the fasteners in the fixture is considered linear
- All fasteners in the group have identical axial stiffness
- In the zone of compression under the fixture, fasteners do not take up normal forces
- The concrete resistance of groups of fasteners is affected by the eccentricity of the total tensile force on the group
- Additional prying forces, which typically arise on a flexible baseplate, are neglected (see Fig. 5.3)

Regarding the latter point, while EN 1992-4 [2] does not provide clear guidelines for flexible fixtures, these additional prying forces can be determined using specialized software. For instance, Hilti's PROFIS Engineering software includes an advanced baseplate module which accounts for flexible baseplate assumptions by applying the Component-Based Finite Element Method (CBFEM). In timber connections, this may be of importance when designing any metal connectors and brackets with small thickness and no transversal stiffeners.

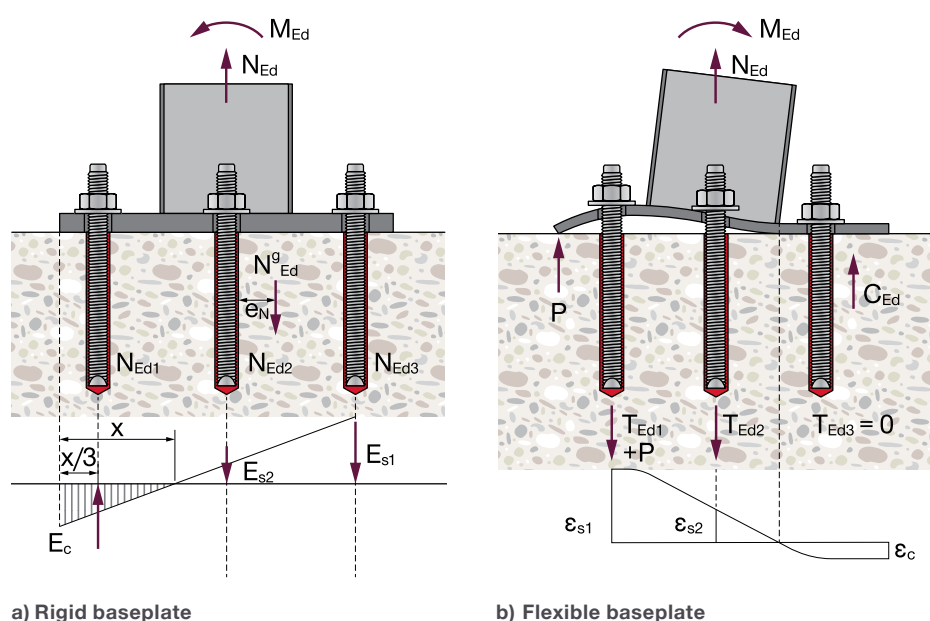

Fig. 5.3: Strain distribution for fastening system subjected to tensile force and bending moment

With regards to shear forces acting on groups of fasteners, the provisions in EN 1992-4 [2] assume that only the front row anchors resist shear when placed close to a concrete edge and the shear force is acting orthogonally to such edge. Conversely, if the shear acts parallel, in case of additional torsional effects, or if the fixing is not close to the concrete edge, all anchors are considered to take up shear loads. When dealing with multiple edges (as, for example, in the corner of a concrete slab), each edge must be separately verified.

Typically, structural engineers utilize commercially available software to design timber-to-concrete connections. The design examples in this chapter are calculated with Hilti's PROFIS Engineering software. The latter has been used to model both the metal connectors (e.g., holdown, bracket, shear plate, etc.) and the fasteners. For simplicity, all these examples assume ultimate limit state and rigid baseplate. The example shows some different applications, load conditions and geometric constraints, according to the typical requirements of timber structures. We encourage you to test our software, and to contact our team of experts for any technical support or guidance needed in the design of your fastening points.

## 5.1. A checklist before starting to design post-installed anchors

Before approaching the design of timber-to-concrete connections, the following list (Fig. 5.4) encompasses the key points to take into account:

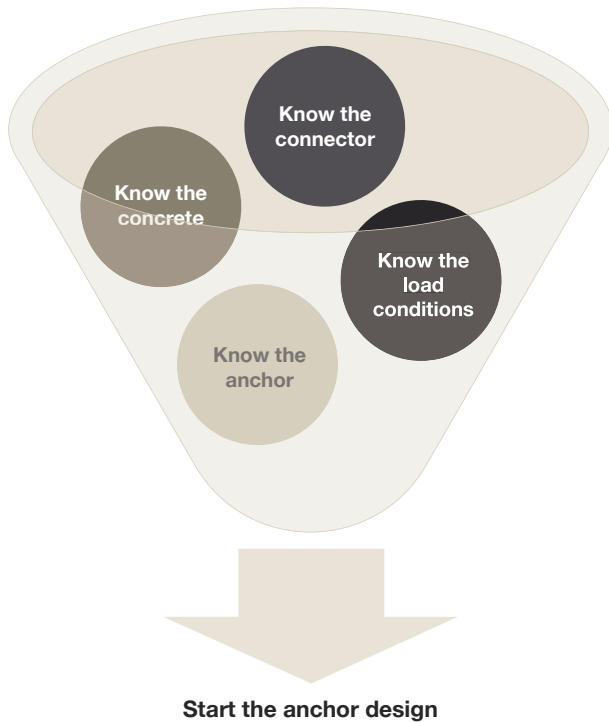

Fig. 5.4: Four things to know before starting the design of anchors

1. Know the **properties of the connector** (e.g., for holddown, angle bracket, etc.):
  - **Clearance holes position:** anchors positioned closer together have lower load capacity; load eccentricities further increase the forces acting on the anchors.
  - **Clearance hole diameter:** this limits the anchor diameters compatible with the connector.
  - **Bracket/plate thickness:** while the anchor embedment depth is dictated by the load-carrying capacity requirements, the fixture thickness must be considered when determining the total anchor length. Further, the smaller the fixture thickness, the less rigid the fixture.
  - **Material type of the connector and corrosion requirements:** these should drive the choice of the anchor material and coating.
2. Know the **concrete properties** and where the connector must be placed:
  - **Concrete class:** the concrete strength affects the anchor's performance. Mechanical anchors, for example, can have up to 50% higher resistance in tension in high strength concrete (C50/60) compared with the standard reference strength concrete (C20/25).
  - **Uncracked / cracked concrete:** when designing for cracked concrete conditions, which should be the most common scenario, the anchor performance is significantly lower than in uncracked concrete. Further, only anchor assessed for use in cracked concrete may be used, if cracked concrete is assumed in design.
  - **Edge distance:** the anchor performance is heavily affected by the anchor's distance from the concrete edge, which limits the volume of concrete that the anchor can engage both in tension and in shear.
3. Know the **load conditions:**
  - **Load type:** anchors must be qualified and approved for the relevant load conditions. For example, in seismic areas, only anchors assessed for use under seismic loads should be used. Further, the

anchor resistance under static loads must be reduced when designing for seismic or dynamic fatigue loads according to the relevant design method and ETA.

4. Know the **anchor properties** and documentation:

- **Anchor technology:** this can have a significant impact not only on the maximum load-carrying capacity, but also on the ease of installation. For example, bonded anchors can have higher resistance and can generally be installed at smaller edge distances. However, mechanical anchors are simpler and faster to install.
- **Familiarize with the anchor ETA:** the European Technical Assessment reports the load and geometrical conditions for which the anchor is approved. It also includes all the parameters influencing the design calculations, as well as the installation requirements such as minimum concrete edge distances, minimum spacing between anchors and minimum approved embedment depth. If you use software like Hilti's PROFIS Engineering, the anchor ETA parameters will be already accounted for within the software calculations.

There may be other aspects you need to consider in your design. However, the key aspects listed above should affect most, if not all, the designs of timber-to-concrete connections. We strongly encourage you to use specialized software such as Hilti's PROFIS Engineering, since it will significantly help to ease and speed up your design and anchor selection processes.

## 5.2. Design using Hilti's PROFIS Engineering

The design examples presented in this chapter are calculated with Hilti's PROFIS Engineering software. The software generates a comprehensive report, including all the required equations and background calculations. These are all detailed in the following examples, highlighting relevant failure modes and references from EN 1992-4 [2].

In order to get you started, this section presents a streamlined design flow (see Fig. 5.5) that illustrates how the software can be used for designing timber-to-concrete connections. This overview is intended for new or inexperienced users, who may like to reproduce the examples or develop similar designs on their own. It does not comprehensively explain all PROFIS Engineering features, but users are still encouraged to explore the different options offered by the software.

The figure displays four screenshots of the Hilti PROFIS Engineering software interface, illustrating a design workflow for timber-to-concrete connections.

- a) Select concrete fixing module:** Shows the 'APPLICATIONS' section with options like 'Anchoring to Concrete', 'Anchoring to Masonry', 'Handrail', 'Concrete overlay', 'Post-installed rebar', and 'Wood Connections'.
- b) Define properties of base material:** Shows the 'BASE MATERIAL' and 'GEOMETRY' panels. Parameters include Concrete type (Normal concrete), Concrete thickness (250 mm), Cracked concrete (checked), C20/25,  $f_{c,eff}$  (20 N/mm<sup>2</sup>),  $f_{c,cube}$  (25 N/mm<sup>2</sup>), and various edge distances (Infinity).
- c) Define geometry of connector:** Shows the 'ANCHOR PLATE DESIGN' and 'PROFILE' panels. Parameters include 'Use profile' (checked), IPBi/HEA, Height (133 mm), Width (140 mm), Flange thickness (8.5 mm), and Thickness (5.5 mm). The selected profile is IPBi 140 / HE 140 A.
- d) Select Anchor family and diameter:** Shows the 'ANCHOR' panel with a search bar and a list of anchor families including HUS4-H, HUS4-C, and HUS4-A, each with a description of the mortar and anchor type.



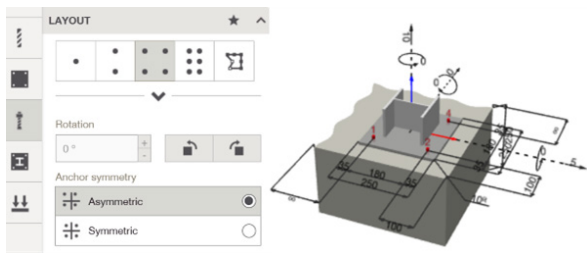

e) Finalise geometry of fixture

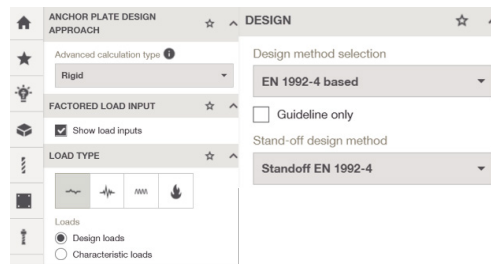

f) Select load type and design method

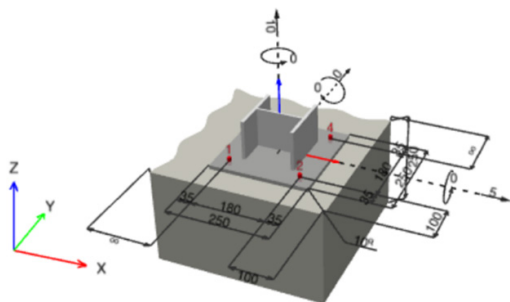

| N° | Name          | Type | Forces [kN] |    |    | Moments [kNm] |    |    |
|----|---------------|------|-------------|----|----|---------------|----|----|
|    |               |      | Vx          | Vy | N  | Mx            | My | Mz |
| 1  | Combination 1 |      | 5           | 0  | 10 | 0             | 0  | 0  |

g) Input forces, moments acting on fixture

| Tension |                       | Shear |                            |
|---------|-----------------------|-------|----------------------------|
|         | Steel 7%              |       | Steel 7%                   |
|         | Concrete breakout 41% |       | Concrete edge breakout 51% |
|         | Pullout 48%           |       | Pryout 18%                 |
|         | Splitting 0%          |       |                            |

| Combination |              |
|-------------|--------------|
|             | Steel 1%     |
|             | Concrete 68% |

h) Check results and print the design report

Fig. 5.5: Design flow in PROFIS Engineering

- Select the Concrete fixing module.** This will open an editable 3D graphical interface at the center of your screen, with input tabs on the left for design variables and a vertical box on the right, which shows the design outputs and any useful notification.
- Define the properties of the base material,** such as whether the concrete is uncracked or cracked, its strength, and the geometry of the base material.
- Define the geometry of your connector** (e.g., holdown, steel bracket or plate) using the baseplate and the profile design tab. You can also directly edit the 3D representation at the center of the screen.
- Select the anchor family and diameter** (you can change these later to compare different solutions) based on the connection requirements and preferred installation. The anchor selector menu can be opened from either its tab on the left, or from the upper-right corner of the 3D interface. Within the selector menu, anchor families can be filtered based on attributes such as type, material, and installation parameters, while icons indicate the relevant approvals for specific application requirements (e.g., anchors approved for seismic loads, fatigue, fire exposure etc.)
- Finalize the geometry of the fixture** considering anchor positioning, spacing, and concrete edge distance (this may have changed from your initial setup if you have modified your anchor layout or the anchors' positions). The anchor layout can be changed via the anchor tab. The other geometrical parameters can be easily edited through the 3D interface.
- Select the load type** (static, seismic, fatigue or fire) and **the design method** to be adopted among those available in your geographical region and for the chosen anchor. Additionally, choose between rigid baseplate (standard Eurocode approach) and the advanced calculation module, which uses the Component-Based Finite Element Method (CBFEM) to derive the loads on the anchors considering a flexible plate. Note that all the examples in this handbook use the rigid baseplate assumption.
- Input forces and moments acting on the fixture.** You can do this either in the graphical interface, or in the table located at the bottom of your screen. You can also input multiple load combinations

at once. The software will automatically determine the forces on the anchors, which are shown in the “Anchor loads” table at the top right of your screen.

8. **Verify the anchor’s utilization and generate the report.** With all the inputs defined, the software updates in real time the anchor utilization for each failure mode in tension, shear and combination, as shown on the right side of the screen. The software also determines the optimal anchor embedment depth to achieve the required performance with the shortest possible anchor. At the top right of the screen, you can finally generate a comprehensive design report, which includes the design calculations, the specifications for the selected anchors, and the relevant information for their installation.

### 5.3. Example #1: Connection between timber wall and concrete foundation with holdowns and bonded anchors

#### 5.3.1. Brief description of the application

**Application:** vertical timber panel fastened to a concrete slab with holdowns, equally spaced along the panel. The most critical holdown is designed, the same fastening solution is used for all the holdowns.

**Actions on fixture:** a vertical uplift force of 15 kN acts on the holddown. Only static loads are considered in the design.

**Geometrical constraints:** The holddown is placed close to the edge of the concrete. The distance from the edge of the concrete to the center of the anchor is  $c=100$  mm. The spacing between the holdowns is sufficiently large to consider no influence between anchors. The relevant geometrical features of the holddown are shown in Fig. 5.6. A single anchor is to fasten the holddown to the concrete.

**Concrete foundation characteristics:** The thickness of the concrete foundation is  $h=500$  mm. Normal weight concrete is used for the concrete foundation, with concrete class C25/30. The design is done in cracked concrete.

**Materials and service life:** 50 years’ design working life is considered in the design. This is an indoor application with no specific corrosion requirements; therefore, all elements of the connections are in carbon steel.

**PROFIS Engineering model:** The holddown has been modelled in Hilti’s PROFIS Engineering software (refer to [Section 5.2](#)) to determine a suitable fastening solution, as shown in Fig. 5.6, using a 20 mm thick baseplate of size 60x60 mm, and a flat bar profile with 3 mm thickness. The force acting on the holddown is considered acting on the flat bar profile, hence with an eccentricity of 28.5 mm with respect to the anchor. The resulting moment generates a tensile force on the anchor of 32.4 kN. The design is validated according to the EN 1992-4 [2].

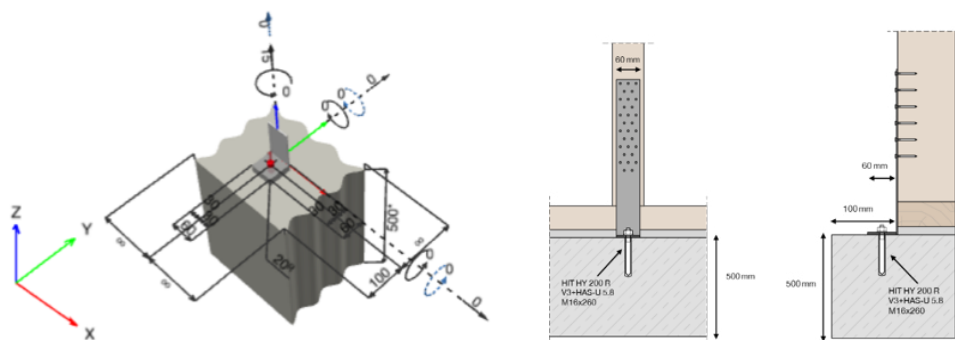

Fig. 5.6: Timber wall to concrete slab fastening via holddown: PROFIS Engineering model and sketch of connection geometry

### 5.3.2. Summary of relevant project information

|                            |   |
|----------------------------|---|
| Materials:                 | Normal weight concrete C25/30 ( $f_{ck} = 25 \text{ N} / \text{mm}^2$ )<br>Cracked concrete<br>Carbon steel anchor rods   |
| Geometry of concrete slab: | Slab thickness, $h = 500 \text{ mm}$  |
| Geometry of holddown:      | Baseplate dimension, $l \times w = 60 \times 60 \text{ mm}$<br>Baseplate thickness, $t = 20 \text{ mm}$<br>Flat bar thickness, $t_b = 3 \text{ mm}$<br>Anchor distance from concrete edge, $c = 100 \text{ mm}$ |
| Loads on holddown:         | Vertical uplift load applied to the holddown, $N = 15 \text{ kN}$   |
| Reinforcement:             | It is considered that reinforcement in the concrete element can control splitting, according to EN 1992-4, 7.2.1.7, by limiting crack widths to $w_k \leq 0.3 \text{ mm}$                                       |
| Design working life:       | 50 years  |

### 5.3.3. Selected post-installed anchor and installation conditions:

|                                |  |
|--------------------------------|--|
| Type of anchor:                | Bonded anchor  |
| Anchor family:                 | Hilti HIT-HY 200-A V3 injection mortar with threaded rod HAS-U<br>5.8 M16x260 (ETA 19/0601 [10]) |
| Number of anchors:             | 1  |
| Drilling method:               | Hammer drilling  |
| Installation/in-service temp.: | 24°C (Long term)/40°C (Short term)   |

Details of selected anchor is defined in Table 5.1:

Table 5.1: Anchor properties

| Type of anchor            | Chemical                    |        |
|---------------------------|-----------------------------|--------|
| Specification of anchor   | HIT-HY 200-A V3 + HAS U 5.8 |        |
| Diameter of anchor        | $d$                         | 16 mm  |
| Effective embedment depth | $h_{ef}$                    | 173 mm |



### 5.3.4. Resulting anchor forces

The moment due to the eccentricity of the tensile load on the holddown generates a compression force between the baseplate and the concrete, and a tensile force on the anchor. There are no shear forces acting on the holddown or the anchor (Table 5.2).

Table 5.2: Anchor forces

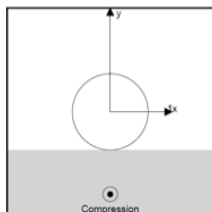

| Anchor | Tension force | Shear force x | Shear force y |
|--------|---------------|---------------|---------------|
| 1      | 32.4 kN       | 0 kN          | 0 kN          |

### 5.3.5. Design verification for failure modes against tension loads

Design verifications are carried considering rigid baseplate as per EN 1992-4 [2] Sect. 7.2.1. and characteristic resistances are taken from ETA-19/0601 [10].

#### Verification for steel failure:

For a single anchor, the resultant design tension force on the anchor,  $N_{Ed}$ , must be compared to the design resistance of the fastener in case of steel failure,  $N_{Rd}$ , according to the following equation:

$$N_{Ed} \leq N_{Rd,s} = \frac{N_{Rk,s}}{\gamma_{Ms}} \quad \text{EN 1992-4, Table 7.1}$$

where  $N_{Rk,s}$  is the characteristic resistance of the fastener in case of steel failure, and  $\gamma_{Ms}$  is the partial factor for steel failure, both indicated in the relevant ETA.

$$N_{Rk,s} = A_s \cdot f_{uk} = 157 \cdot 500 = 78.5 \text{ kN} \quad \text{ETA-19/0601, Table C.1}$$

$$\gamma_{Ms} = 1.5 \quad \text{ETA-19/0601, Table C.1}$$

$$N_{Ed} = 32.4 \text{ kN} \leq N_{Rd,s} = \frac{N_{Rk,s}}{\gamma_{Ms}} = \frac{78.5}{1.5} = 52.3 \text{ kN} \quad \text{verification fulfilled } \checkmark$$

#### Verification for concrete cone failure:

The resultant design tension force on the anchor,  $N_{Ed}$ , must be compared to the design resistance in case of concrete cone failure,  $N_{Rd,c}$ , according to the following equation:

$$N_{Ed} \leq N_{Rd,c} = \frac{N_{Rk,c}}{\gamma_{Mc}} \quad \text{EN 1992-4, Table 7.1}$$

where  $N_{Rk,c}$  is the characteristic resistance of the anchor in case of concrete cone failure, and  $\gamma_{Mc}$  is the partial factor for concrete cone, concrete edge, concrete blow-out and concrete pry-out failure modes. The latter is defined, for permanent design situations, as the product:

$$\gamma_{Mc} = \gamma_c \cdot \gamma_{inst} = 1.5 \cdot 1.0 = 1.5 \quad \text{EN 1992-4, Table 4.1 and ETA-19/0601, Table C.1}$$

with  $\gamma_c = 1.5$  according to the EN 1992-4 [2], and  $\gamma_{inst}$  being the factor accounting for the sensitivity to installation of the post-installed fastener, defined in the relevant ETA.

With regards to  $N_{Rk,c}$ , this is determined as the product of the characteristic resistance of a single fastener placed in concrete and not influenced by adjacent fasteners or edges of the concrete member,  $N_{Rk,c}^0$ , and coefficients which take into account for geometric effects and the presence of other anchors if a group of fasteners is designed:

$$N_{Rk,c} = N_{Rk,c}^0 \cdot \frac{A_{c,N}}{A_{c,N}^0} \cdot \psi_{s,N} \cdot \psi_{re,N} \cdot \psi_{ec,N} \cdot \psi_{M,N} \quad \text{EN 1992-4, eq. (7.1)}$$

$N_{Rk,c}^0$  is determined according to:

$$N_{Rk,c}^0 = k_1 \cdot \sqrt{f_{ck}} \cdot h_{ef}^{1.5} = 7.7 \cdot \sqrt{25} \cdot 173^{1.5} = 87,605 \text{ N} = 87.6 \text{ kN} \quad \text{EN 1992-4, eq. (7.2)}$$

where the coefficient  $k_1$  is given in the relevant ETA for cracked and uncracked concrete conditions, and the concrete strength and anchor effective embedment depths have already been defined in [Sections 5.3.2](#) and [5.3.3](#).

$A_{c,N}^0$  is the reference concrete cone projected area, while  $A_{c,N}$  is the actual projected area limited by overlapping concrete cones (in case of adjacent fasteners), as well as concrete edges. These are defined as a function of the distance  $c$  from the edge of the concrete member, the spacing from other fasteners  $s$  (not relevant in this case, since a single fastener is considered), the characteristic spacing and edge distances to ensure the concrete cone resistance of the individual fastener,  $c_{cr,N}$  and  $s_{cr,N}$ , defined in the relevant ETA.

$$A_{c,N}^0 = s_{cr,N} \cdot s_{cr,N} = 519.0 \cdot 519.0 = 269,361 \text{ mm}^2 \quad \text{EN 1992-4, eq. (7.3) and ETA-19/0601 Table C1}$$

$$A_{c,N} = s_{cr,N} \cdot (0.5s_{cr,N} + c) = 519.0 \cdot (259.5 + 100) = 186,580 \text{ mm}^2$$

The coefficients  $\psi_{s,N}$  and  $\psi_{re,N}$  consider, respectively, the disturbance on the stress distribution due to proximity to the edge of the concrete member, and the spalling due to dense reinforcement in the area where the fastener is installed.  $\psi_{ec,N}$  accounts for group effect when different loads are acting on the individual fasteners of a group. Finally,  $\psi_{M,N}$  describes the effects of compressive forces between fixture and concrete in case of bending moments.

$$\psi_{s,N} = 0.7 + 0.3 \frac{c}{c_{cr,N}} = 0.7 + 0.3 \frac{100}{259.5} = 0.816 \quad \text{EN 1992-4, eq. (7.4) and ETA-19/0601 Table C1}$$

$$\psi_{re,N} = 1.0 \text{ (no dense reinforcement)} \quad \text{EN 1992-4, eq. (7.5)}$$

$$\psi_{ec,N} = 1.0 \text{ (single anchor)} \quad \text{EN 1992-4, eq. (7.6)}$$

$$\psi_{M,N} = 1.0 \text{ (when } c < 1.5h_{ef}\text{)} \quad \text{EN 1992-4, eq. (7.7)}$$

Based on the above:

$$N_{Rk,c} = N_{Rk,c}^0 \cdot \frac{A_{c,N}}{A_{c,N}^0} \cdot \psi_{s,N} \cdot \psi_{re,N} \cdot \psi_{ec,N} \cdot \psi_{M,N} = 48.7 \text{ kN} \quad \text{EN 1992-4, eq. (7.1)}$$

$$N_{Ed} = 32.4 \text{ kN} \leq N_{Rd,c} = \frac{N_{Rk,c}}{\gamma_{Mc}} = \frac{48.7}{1.5} = 32.4 \text{ kN} \quad \text{verification fulfilled} \checkmark$$

#### Verification for combined pullout and concrete cone failure:

The resultant design tension force on the anchor,  $N_{Ed}$ , must be compared to the design resistance in case of combined pullout and concrete cone failure,  $N_{Rd,p}$ , according to the following equation:

$$N_{Ed} \leq N_{Rd,p} = \frac{N_{Rk,p}}{\gamma_{Mp}} \quad \text{EN 1992-4, Table 7.1}$$

where  $N_{Rk,p}$  is the characteristic resistance of the anchor in case of combined pullout and concrete failure, and  $\gamma_{Mp}$  is the partial factor for pullout and combined pullout and concrete failure. The latter is defined, for permanent design situations, as:

$$\gamma_{Mp} = \gamma_{Mc} = \gamma_c \cdot \gamma_{inst} = 1.5 \cdot 1.0 = 1.5 \quad \text{EN 1992-4, Table 4.1 and ETA-19/0601, Table C.1}$$

with  $\gamma_c = 1.5$  according to the EN 1992-4 [2], and  $\gamma_{inst}$  being the factor accounting for the sensitivity to installation of the post-installed fastener, defined in the relevant ETA.

Following an approach similar to concrete cone failure,  $N_{Rk,p}$  is determined as the product of the characteristic resistance of a single fastener placed in concrete and not influenced by adjacent fasteners or edges of the concrete member,  $N_{Rk,p}^0$ , and coefficients which account for geometric effects and the presence of other anchors if a group of fasteners is designed:

$$N_{Rk,p} = N_{Rk,p}^0 \cdot \frac{A_{p,N}}{A_{p,N}^0} \cdot \psi_{g,Np} \cdot \psi_{s,Np} \cdot \psi_{re,N} \cdot \psi_{ec,Np} \quad \text{EN 1992-4, eq. (7.13)}$$

The first term is determined according to:

$$N_{Rk,p}^0 = \psi_{sus} \cdot \tau_{Rk,cr} \cdot \pi \cdot d \cdot h_{ef} \quad \text{EN 1992-4, eq. (7.14) and ETA-19/0601, Table C.1}$$

$$N_{Rk,p}^0 = 1 \cdot 9.71 \cdot \pi \cdot 16 \cdot 173 = 84,475 \text{ N} = 84.5 \text{ kN}$$

where  $d$  and  $h_{ef}$  are the diameter and embedment depth of the anchor, respectively; the coefficient  $\psi_{sus}$  takes into account for the influence of sustained loads (EN 1992-4, eq 7.14a);  $\tau_{Rk,cr}$  is the characteristic bond resistance of the bonded fastener in cracked concrete, as defined in the relevant ETA. Note that the latter value has to be selected for the relevant temperature range (in this example,  $\tau_{Rk,cr} = 9.71 \text{ N/mm}^2$  for temperature range I).

Similar to the case of concrete cone failure,  $A_{p,N}^0$  and  $A_{p,N}$  consider the effects of anchor spacing and concrete edge distance. They are determined with the same equations used for  $A_{c,N}^0$  and  $A_{c,N}$  (see verification for concrete cone failure), but replacing the parameters  $c_{cr,N}$  and  $s_{cr,N}$  with  $c_{cr,Np}$  and  $s_{cr,Np}$ , the latter defined as:

$$s_{cr,Np} = 7.3 \cdot d \cdot \sqrt{\psi_{sus} \cdot \tau_{Rk,ucr,C20/25}} \leq 3h_{ef} = 519 \text{ mm} \quad \text{EN 1992-4, eq. (7.15)}$$

$$c_{cr,Np} = s_{cr,Np} / 2 = 259.5 \text{ mm} \quad \text{EN 1992-4, eq. (7.16)}$$

with  $\tau_{Rk,ucr,C20/25}$  the characteristic bond resistance of the bonded fastener in uncracked concrete and concrete class C20/25, defined in the relevant ETA.

Accordingly, the values of  $A_{p,N}^0$  and  $A_{p,N}$  can be calculated as:

$$A_{p,N}^0 = s_{cr,Np} \cdot s_{cr,Np} = 519.0 \cdot 519.0 = 269,361 \text{ mm}^2 \quad \text{EN 1992-4, eq. (7.3)}$$

$$A_{p,N} = s_{cr,Np} \cdot (0.5s_{cr,Np} + c) = 519.0 \cdot (259.5 + 100) = 186,580 \text{ mm}^2$$

The factor  $\psi_{g,Np}$  takes into account for a group effect for closely spaced bonded fasteners. Since in this case a single fastener is used, this factor assumes unitary value.

The factor  $\psi_{re,N}$  has already been determined for the concrete cone failure mode verification, the same value is used here.

The factor  $\psi_{s,Np}$  and  $\psi_{ec,Np}$  are determined with the same equations introduced for the concrete cone failure mode verification, but replacing the parameters  $c_{cr,N}$  and  $s_{cr,N}$  with  $c_{cr,Np}$  and  $s_{cr,Np}$ :

$$\psi_{s,Np} = 0.7 + 0.3 \cdot \frac{c}{c_{cr,Np}} = 0.7 + 0.3 \cdot \frac{100}{259} = 0.816 \quad \text{EN 1992-4, eq. (7.20) and ETA-19/0601 Table C1}$$

$$\psi_{ec,Np} = 1.0 \text{ (single anchor)} \quad \text{EN 1992-4, eq. (7.21)}$$

Based on the above:

$$N_{Rk,p} = N_{Rk,p}^0 \cdot \frac{A_{p,N}}{A_{p,N}^0} \cdot \psi_{g,Np} \cdot \psi_{s,Np} \cdot \psi_{re,N} \cdot \psi_{ec,Np} = 33.0 \text{ kN} \quad \text{EN 1992-4, eq. (7.1)}$$

$$N_{Ed} = 33.0 \text{ kN} \leq N_{Rd,c} = N_{Rk,c} / \gamma_{Mc} = 49.516 / 1.5 = 33.0 \text{ kN} \quad \text{verification fulfilled} \checkmark$$

#### Verification for splitting:

No concrete splitting failure verification is required if the design is done in cracked concrete and it is assumed that reinforcement resists the splitting forces and limits the crack width to  $w_k \leq 0.3 \text{ mm}$  (see [Section 5.3.2](#))

### 5.3.6. Alternative Hilti anchors suitable for the application

Alternative Hilti anchors which can be suited for this project requirement is defined in Table 5.3.

Table 5.3: Anchor properties

| Type of anchor            | Chemical                 |        |
|---------------------------|--------------------------|--------|
| Specification of anchor   | HVU2 capsule + HAS-U 5.8 |        |
| Diameter of anchor        | $d$                      | 16 mm  |
| Effective embedment depth | $h_{ef}$                 | 190 mm |



## 5.4. Example #2: Connection between timber panel and concrete slab with angle bracket and screw anchors

### 5.4.1. Brief description of the application

**Application:** vertical timber panel fastened to a concrete slab with angle bracket equally spaced along the panel. The most critical bracket is designed, the same fastening solution is used for all the brackets.

**Actions on fixture:** a vertical uplift force of 10 kN, and shear forces in orthogonal directions (12 kN and 6 kN) act on the bracket. Static loads are considered in the design.

**Geometrical constraints:** The bracket is placed close to the edge of the concrete. The distance from the edge of the concrete to the center of the anchor is  $c = 100 \text{ mm}$ . The 6 kN shear force acts orthogonally to the concrete edge, while the 12 kN shear force acts parallel to the edge. The spacing between the brackets is sufficiently large to consider no influence between brackets. The relevant geometrical features of the bracket are shown in Fig. 5.7. Two anchors are used to fasten the bracket to the concrete.

**Concrete foundation characteristics:** The thickness of the concrete foundation is  $h = 200 \text{ mm}$ . Normal weight concrete is used for the concrete foundation, with concrete class C30/35. The design is done in cracked concrete.

**Materials and service life:** 50 years design working life is considered in the design. This is an indoor application with no specific corrosion requirements; therefore, all elements of the connections are in carbon steel.

**PROFIS Engineering model:** The bracket has been modelled in Hilti's PROFIS Engineering software to determine a suitable fastening solution, as shown in Fig. 5.7, using a 5 mm thick baseplate of size 200x100 mm, and a flat bar profile with 5 mm thickness. The forces acting on the bracket are considered acting on the flat bar profile, hence with an eccentricity with respect to the anchor. The resulting tensile and shear forces on the anchors are indicated in [Section 5.4.4](#). The design is validated according to the EN 1992-4 [2].

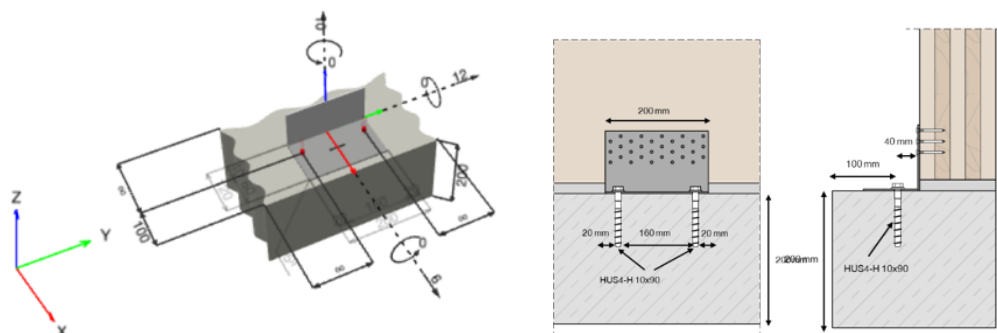

Fig. 5.7: Timber wall to concrete slab fastening via angle bracket: PROFIS Engineering model and sketch of connection geometry

### 5.4.2. Summary of relevant project information

|                            |  |
|----------------------------|--|
| Materials:                 | Normal weight concrete C30/35 ( $f_{ck} = 30 \text{ N} / \text{mm}^2$ )<br>Cracked concrete<br>Carbon steel anchor rods  |
| Geometry of concrete slab: | Slab thickness, $h = 200 \text{ mm}$   |
| Geometry of bracket:       | Baseplate dimension, $l \times w = 200 \times 100 \text{ mm}$<br>Baseplate thickness, $t = 5 \text{ mm}$<br>Flat bar thickness, $t_b = 5 \text{ mm}$<br>Anchor distance from concrete edge, $c = 100 \text{ mm}$<br>Anchor spacing, $s = 160 \text{ mm}$ |

Loads on bracket: Vertical uplift load applied to the bracket,  $N = 10 \text{ kN}$   
 Shear force orthogonal to the concrete edge,  $V_x = 6 \text{ kN}$   
 Shear force parallel to the concrete edge,  $V_y = 12 \text{ kN}$

Reinforcement: It is considered that reinforcement in the concrete element can control splitting, according to EN 1992-4, 7.2.1.7, by limiting crack widths to  $w_k \leq 0.3 \text{ mm}$

Design working life: 50 years

### 5.4.3. Selected post-installed anchor

Type of anchor: Screw anchor  
 Anchor family: Hilti HUS4-H (ETA 20/0867 [9])  
 Number of anchors: 2  
 Drilling method: Hammer drilling  
 Installation/in-service temp.: 24°C (Long term)/40°C (Short term)

Details of selected anchor is defined in Table 5.4:

Table 5.4: Anchor properties

| Type of anchor            | Mechanical |       |
|---------------------------|------------|-------|
| Specification of anchor   | HUS4-H     |       |
| Diameter of anchor        | $d$        | 10 mm |
| Effective embedment depth | $h_{ef}$   | 68 mm |
| Nominal embedment depth   | $h_{nom}$  | 85 mm |



### 5.4.4. Resulting anchor forces

The moment due to the eccentricity of the forces on the bracket generates a compression force between the baseplate and the concrete, an additional tensile force on the anchor, and uneven shear force distribution on the anchors due to torque (Table 5.5).

Table 5.5: Anchor forces

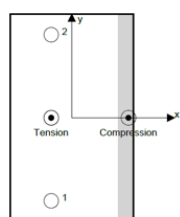

| Anchor | Tension force | Shear force x | Shear force y |
|--------|---------------|---------------|---------------|
| 1      | 7.5 kN        | 0.15 kN       | 6.0 kN        |
| 2      | 7.5 kN        | 5.85 kN       | 6.0 kN        |

### 5.4.5. Design verification for failure modes against tension loads

Design verifications are carried considering rigid baseplate as per EN 1992-4 [2] Sect. 7.2.1 and characteristic resistances are taken from ETA-20/0867 [9].

#### Verification for steel failure:

For a group of anchors, only the most loaded fastener must be verified for steel failure in tension. In this design example, the same tensile force is acting on both anchors. The resultant design tension force on one anchor,  $N_{Ed}$ , must be compared to the design resistance of the anchor in case of steel failure,  $N_{Rd}$ , according to the following equation:



$$N_{Ed} \leq N_{Rd,s} = \frac{N_{Rk,s}}{\gamma_{Ms}} \quad \text{EN 1992-4, Table 7.1}$$

where  $N_{Rk,s}$  is the characteristic value of steel resistance of the fastener under tension load, and  $\gamma_{Ms}$  is the partial factor for steel failure, both indicated in the relevant ETA.

$$N_{Rk,s} = 55.0 \text{ kN} \quad \text{ETA-20/0867, Table C.1}$$

$$\gamma_{Ms} = 1.5 \quad \text{ETA-20/0867, Table C.1}$$

$$N_{Ed} = 7.5 \text{ kN} \leq N_{Rd,s} = \frac{N_{Rk,s}}{\gamma_{Ms}} = \frac{55.0}{1.5} = 36.7 \text{ kN} \quad \text{verification fulfilled } \checkmark$$

#### Verification for concrete cone failure:

The resultant design tension force on the group of anchors,  $N_{Ed}$ , must be compared to the design resistance of the group of fasteners in case of concrete cone failure,  $N_{Rd,c}$ , according to the following equation:

$$N_{Ed} \leq N_{Rd,c} = \frac{N_{Rk,c}}{\gamma_{Mc}} \quad \text{EN 1992-4, Table 7.1}$$

where  $N_{Rk,c}$  is the characteristic resistance of the group of fasteners in case of concrete cone failure, and  $\gamma_{Mc}$  is the partial factor for concrete cone, concrete edge, concrete blow-out and concrete pry-out failure modes. The latter is defined, for permanent design situations, as the product:

$$\gamma_{Mc} = \gamma_c \cdot \gamma_{inst} = 1.5 \cdot 1.0 = 1.5 \quad \text{EN 1992-4, Table 4.1 and ETA-20/0867, Table C.1}$$

with  $\gamma_c = 1.5$  according to the EN 1992-4 [2], and  $\gamma_{inst}$  being the factor accounting for the sensitivity to installation of the post-installed fastener, defined in the relevant ETA.

With regards to  $N_{Rk,c}$ , this is determined as the product of the characteristic resistance of a single fastener placed in concrete and not influenced by adjacent fasteners or edges of the concrete member,  $N_{Rk,c}^0$ , and coefficients which take into account for geometric effects and the presence of other anchors if a group of fasteners is designed:

$$N_{Rk,c} = N_{Rk,c}^0 \cdot \frac{A_{c,N}}{A_{c,N}^0} \cdot \psi_{s,N} \cdot \psi_{re,N} \cdot \psi_{ec,N} \cdot \psi_{M,N} \quad \text{EN 1992-4, eq. (7.1)}$$

The first term is determined according to:

$$N_{Rk,c}^0 = k_1 \cdot \sqrt{f_{ck}} \cdot h_{ef}^{1.5} = 7.7 \cdot \sqrt{30} \cdot 68^{1.5} = 23,649 \text{ N} = 23.6 \text{ kN} \quad \text{EN 1992-4, eq. (7.2)}$$

where the coefficient  $k_1$  is given in the relevant ETA for cracked and uncracked concrete conditions, and the concrete strength and anchor effective embedment depths have already been defined in [Sections 5.4.2](#) and [5.4.3](#).

$A_{c,N}^0$  is the reference concrete cone projected area for the anchor group, while  $A_{c,N}$  is the actual projected area limited by overlapping concrete cones as well as concrete edges. These are defined as a function of the distance  $c$  from the edge of the concrete member, the spacing from other fasteners  $s$ , the characteristic spacing and edge distances to ensure the concrete cone resistance of the individual fastener,  $c_{cr,N}$  and  $s_{cr,N}$ , defined in the relevant ETA.

$$A_{c,N}^0 = s_{cr,N} \cdot s_{cr,N} = 204.0 \cdot 204.0 = 41,616 \text{ mm}^2 \quad \text{EN 1992-4, eq. (7.3) and ETA-20/0867 Table C1}$$

$$A_{c,N} = (0.5s_{cr,N} + s + 0.5s_{cr,N}) \cdot (0.5s_{cr,N} + c) = (102 + 160 + 102) \cdot (102 + 100) = 73,528 \text{ mm}^2$$

The coefficients  $\psi_{s,N}$  and  $\psi_{re,N}$  consider, respectively, the disturbance on the stress distribution due to proximity to the edge of the concrete member, and the spalling due to dense reinforcement in the area where the fastener is installed.  $\psi_{ec,N}$  accounts for group effect when different loads are acting on the individual fasteners of a group. Finally,  $\psi_{M,N}$  describes the effects of compressive forces between fixture and concrete in case of bending moments.

$$\psi_{s,N} = 0.7 + 0.3 \cdot \frac{c}{c_{cr,N}} = 0.7 + 0.3 \cdot \frac{100}{102} = 0.994 \quad \text{EN 1992-4, eq. (7.4) and ETA-20/0867 Table C1}$$

$$\psi_{re,N} = 1.0 \text{ (no dense reinforcement)} \quad \text{EN 1992-4, eq. (7.5)}$$

$$\psi_{ec,N} = 1.0 \text{ (same tension loads on all anchors)} \quad \text{EN 1992-4, eq. (7.6)}$$

$$\psi_{M,N} = 1.0 \text{ (when } c < 1.5h_{ef}\text{)} \quad \text{EN 1992-4, eq. (7.7)}$$

Based on the above:

$$N_{Rk,c} = N_{Rk,c}^0 \cdot \frac{A_{c,N}}{A_{c,N}^0} \cdot \psi_{s,N} \cdot \psi_{re,N} \cdot \psi_{ec,N} \cdot \psi_{M,N} = 41.5 \text{ kN} \quad \text{EN 1992-4, eq. (7.1)}$$

$$N_{Ed} = 15.1 \text{ kN} \leq N_{Rd,c} = \frac{N_{Rk,c}}{\gamma_{Mc}} = \frac{41.5}{1.5} = 27.7 \text{ kN} \quad \text{verification fulfilled} \checkmark$$

#### Verification for pullout failure:

The pull-out failure is verified for the most loaded fastener in tension. In this case, the same tensile force is acting on both anchors. The resultant design tension force,  $N_{Ed}$ , must be compared to the design resistance of one anchor in case of pullout failure,  $N_{Rd,p}$ , according to the following equation:

$$N_{Ed} \leq N_{Rd,p} = \frac{N_{Rk,p}}{\gamma_{Mp}} \quad \text{EN 1992-4, Table 7.1}$$

where  $N_{Rk,p}$  is the characteristic resistance of the anchor in case of pullout failure,  $\gamma_{Mp}$  is the partial factor for pull-out. The latter is defined, for permanent design situations, as:

$$\gamma_{Mp} = \gamma_{Mc} = \gamma_c \cdot \gamma_{inst} = 1.5 \cdot 1.0 = 1.5 \quad \text{EN 1992-4, Table 4.1 and ETA-20/0867, Table C.1}$$

with  $\gamma_c = 1.5$  according to the EN 1992-4, and  $\gamma_{inst}$  being the factor accounting for the sensitivity to installation of the post-installed fastener, defined in the relevant ETA.

For the reference concrete strength C20/25,  $N_{Rk,p(C20/25)}$  is defined in the relevant European Technical Product Specification, in this case ETA-20/0867 [9]:

$$N_{Rk,p(C20/25)} = 19.3 \text{ kN} \quad \text{ETA-20/0867, Table C.1}$$

To account for the anchor's improved performance in case of higher concrete strength, the increasing factor  $\psi_c$  must be considered. The latter is defined in the relevant ETA as a function of the concrete strength:

$$\psi_c = \left(\frac{f_{ck}}{20}\right)^{0.5} = \left(\frac{30}{20}\right)^{0.5} = 1.225 \quad \text{ETA-20/0867, Table C.1}$$

$$N_{Rk,p} = \psi_c \cdot N_{Rk,p(C20/25)} = 1.225 \cdot 19.3 = 23.6 \text{ kN}$$

Based on the above:

$$N_{Ed} = 7.5 \text{ kN} \leq N_{Rd,c} = \frac{N_{Rk,p}}{\gamma_{Mp}} = \frac{23.6}{1.5} = 15.8 \text{ kN} \quad \text{verification fulfilled} \checkmark$$

#### Verification for splitting:

No concrete splitting failure verification is required if the design is done in cracked concrete and it is assumed that reinforcement resists the splitting forces and limits the crack width to  $w_k \leq 0.3 \text{ mm}$  (see [Section 5.3.2](#))

#### 5.4.6. Design verification for failure modes against shear loads

Design verifications are carried considering rigid baseplate as per EN 1992-4 [2] Sect. 7.2.2 and characteristic resistances are taken from ETA-20/0867 [9].

Verification for steel failure without lever arm:

For fasteners in a group, only the most loaded fastener must be verified for steel failure in shear. The anchor with the maximum total shear force is, in this case anchor 2, with a total shear force:

$$V_{Ed} = \sqrt{V_x^2 + V_y^2} = \sqrt{5.85^2 + 6^2} = 8.4 \text{ kN}$$

The resultant design tension force on the anchor,  $V_{Ed}$ , must be compared to the design resistance of the fastener in case of steel failure,  $V_{Rd}$ , according to the following equation:

$$V_{Ed} \leq V_{Rd,s} = \frac{V_{Rk,s}}{\gamma_{Ms}} \quad \text{EN 1992-4, Table 7.1}$$

where  $V_{Rk,s}$  is the characteristic resistance of the fastener in case of steel failure, and  $\gamma_{Ms}$  is the partial factor for steel failure in shear. The characteristic resistance in case of shear failure must account for the ductility of the fastener in a group through the ductility factor  $k_7$  indicated, together with the characteristic resistance for single anchor,  $V_{Rk,s}^0$ , in the relevant ETA:

$$V_{Rk,s} = k_7 \cdot V_{Rk,s}^0 = 0.7 \cdot 32.0 = 25.6 \text{ kN} \quad \text{EN 1992-4, eq. (7.34) and ETA-20/0867, Table C.1}$$

The partial factor for steel failure in shear,  $\gamma_{Ms}$ , is also indicated in the relevant ETA:

$$\gamma_{Ms} = 1.25 \quad \text{ETA-20/0867, Table C.1}$$

Based on the above:

$$V_{Ed} = 8.4 \text{ kN} \leq N_{Rd,s} = \frac{N_{Rk,s}}{\gamma_{Ms}} = \frac{25.6}{1.25} = 20.5 \text{ kN} \quad \text{verification fulfilled } \checkmark$$

Verification for pry-out failure:

Pry-out failure is usually verified on the anchor group. However, for anchor groups of fasteners with shear forces (or components thereof) on the individual fasteners in opposing directions, only the most unfavorable fasteners must be verified. This is the case for this design example, due to the torque caused by the eccentricity, with respect to the anchors, of the shear force parallel to the edge.

The design shear force on the most unfavorable fastener (anchor 2 in this case) group of anchors,  $V_{Ed}$  (already calculated in the previous section), must be compared to the design resistance of the fastener in case of pry-out failure,  $V_{Rd,cp}$ , according to the following equation:

$$V_{Ed} \leq V_{Rd,cp} = \frac{V_{Rk,cp}}{\gamma_{Mc}} \quad \text{EN 1992-4, Table 7.1}$$

where  $V_{Rk,cp}$  is the characteristic resistance of the anchor in case of pry-out failure, and  $\gamma_{Mc} = 1.5$  has already been determined in the section related to the concrete cone failure mode.

For mechanical post-installed anchors without supplementary reinforcement,  $V_{Rk,cp}$  is determined as the product of the characteristic resistance to the concrete failure mode for the single fastener under analysis,  $N_{Rk,c}$ , and the pry-out factor  $k_8$  indicated in the relevant ETA:

$$V_{Rk,cp} = k_8 \cdot N_{Rk,c} \quad \text{EN 1992-4, eq. (7.39a)}$$

Note that, in the calculation of  $N_{Rk,c}$ , it must be assumed that there is a virtual edge in the direction of the neighboring fastener at a distance  $c = 0.5s$ . For the selected anchor type and fasteners layout:

$$V_{Rk,cp} = k_8 \cdot N_{Rk,c} = 2.0 \cdot 20.8 = 41.6 \text{ kN} \quad \text{EN 1992-4, eq. (7.39a) and ETA-20/0867, Table C.1}$$

Based on the above:

$$V_{Ed} = 8.4 \text{ kN} \leq V_{Rd,cp} = \frac{V_{Rk,cp}}{\gamma_{Mc}} = \frac{41.6}{1.5} = 27.7 \text{ kN} \quad \text{verification fulfilled } \checkmark$$

#### Verification for concrete edge failure:

Only the fasteners located closest to the edge are used for the verification of concrete edge failure. In this case since the anchors are equally distant from the edge, the group of anchors must be verified.

The design shear force on the group of anchors,  $V_{Ed}$ , must be compared to the design resistance of the fastener in case of concrete edge failure,  $V_{Rd,c}$ , according to the following equation:

$$V_{Ed} \leq V_{Rd,c} = \frac{V_{Rk,c}}{\gamma_{Mc}} \quad \text{EN 1992-4, Table 7.1}$$

where  $V_{Rk,c}$  is the characteristic resistance of the group of anchors in case of concrete edge failure, and  $\gamma_{Mc} = 1.5$  has already been determined in the section related to the concrete cone failure mode.

The characteristic resistance of a group of fasteners loaded towards the edge,  $V_{Rk,c}$ , is determined as the product of the characteristic resistance of a single anchor loaded perpendicular to the edge,  $V_{Rk,c}^0$ , and a number of factors which account for interference between multiple anchors, edge distances, concrete member thickness, direction of the actual shear load, and distribution of the load across fasteners:

$$V_{Rk,c} = V_{Rk,c}^0 \cdot \frac{A_{c,V}}{A_{c,V}^0} \cdot \psi_{s,V} \cdot \psi_{h,V} \cdot \psi_{ec,V} \cdot \psi_{\alpha,V} \cdot \psi_{re,V} \quad \text{EN 1992-4, eq. (7.40)}$$

The characteristic resistance of a single anchor loaded perpendicular to the edge is determined, according to EN 1992-4, as:

$$V_{Rk,c}^0 = k_9 \cdot d_{nom}^\alpha \cdot l_f^\beta \cdot \sqrt{f_{ck}} \cdot c^{1.5} \quad \text{EN 1992-4, eq. (7.41)}$$

where the parameters  $l_f$  and  $d_{nom}$  are given in the relevant ETA,  $f_{ck}$  is the concrete strength,  $c$  is the concrete edge distance,  $k_9 = 1.7$  for cracked concrete, and the other parameters are defined in EN 1992-4 as:

$$\alpha = 0.1 \cdot \left(\frac{l_f}{c}\right)^{0.5} = 0.1 \cdot \left(\frac{85}{100}\right)^{0.5} = 0.092 \quad \text{EN 1992-4, eq. (7.42)}$$

$$\beta = 0.1 \cdot \left(\frac{d_{nom}}{c}\right)^{0.2} = 0.1 \cdot \left(\frac{10}{100}\right)^{0.2} = 0.063 \quad \text{EN 1992-4, eq. (7.43)}$$

$$V_{Rk,c}^0 = k_9 \cdot d_{nom}^\alpha \cdot l_f^\beta \cdot \sqrt{f_{ck}} \cdot c^{1.5} = 1.7 \cdot 10^{0.092} \cdot 85^{0.063} \cdot \sqrt{30} \cdot 100^{1.5} = 15.2 \text{ kN}$$

The ratio  $A_{c,V}/A_{c,V}^0$  accounts for geometrical effects of spacing, further edge distances, and the thickness of the concrete member.  $A_{c,V}^0$  is a reference projected area, and  $A_{c,V}$  is the area of an idealized concrete break-out body limited by the overlapping concrete cones of adjacent fasteners, edges parallel to the load direction, and concrete member thickness. For more details about the calculation of this parameter in different cases, please refer to EN 1992-4 Sect. 7.2.2.5.

$$A_{c,V}^0 = 4.5 \cdot c^2 = 4.5 \cdot 100^2 = 45,000 \text{ mm}^2 \quad \text{EN 1992-4, eq. (7.44)}$$

$$A_{c,V} = (2 \cdot 1.5c + s) \cdot 1.5c = (2 \cdot 1.5 \cdot 100 + 160) \cdot 1.5 \cdot 100 = 69,000 \text{ mm}^2 \quad \text{EN 1992-4, Fig. 7.14}$$

The factor  $\psi_{s,V}$  takes account of the further edges of concrete. Since only one edge is present in this design example, this factor has unitary value in this case.

The factor  $\psi_{h,V}$  accounts for the nonlinear relationship between concrete edge resistance and concrete member thickness, according to the equation.

$$\psi_{h,V} = \left(\frac{1.5c}{h}\right)^{0.5} \geq 1 \quad \text{EN 1992-4, eq. (7.46)}$$

The factor  $\psi_{ec,v}$  accounts for group effects when different shear loads are acting on the individual fastener of a group.

$$\psi_{ec,v} = \frac{1}{1+2e_v/(3c)} = \frac{1}{1+2\cdot 34/(3\cdot 100)} = 0.815 \leq 1 \quad \text{EN 1992-4, eq. (7.47)}$$

The factor  $\psi_{\alpha,v}$  accounts for the influence of a shear load inclined to the edge:

$$\psi_{\alpha,v} = \sqrt{\frac{1}{(\cos \alpha_v)^2 + (0.5 \sin \alpha_v)^2}} = \sqrt{\frac{1}{(\cos 63^\circ)^2 + (0.5 \sin 63^\circ)^2}} = 1.581 \geq 1 \quad \text{EN 1992-4, eq. (7.48)}$$

where  $\alpha_v$  is the angle between the design shear load and a line perpendicular to the verified edge.

The factor  $\psi_{re,v}$  takes account of the effect of reinforcement located on the edge and is considered having unitary value in cracked concrete without edge reinforcement of stirrups.

$$V_{Rk,c} = 15.2 \cdot \frac{69,000}{45,000} \cdot 1.0 \cdot 1.0 \cdot 0.815 \cdot 1.581 \cdot 1.0 = 30.1 \quad \text{EN 1992-4, eq. (7.40)}$$

Based on the above:

$$V_{Ed} = 13.4 \text{ kN} \leq V_{Rd,c} = \frac{V_{Rk,c}}{\gamma_{Mc}} = \frac{30.1}{1.5} = 20.1 \text{ kN} \quad \text{verification fulfilled} \checkmark$$

#### 5.4.7. Design verification for combined tension and shear loads

Design verifications are carried considering rigid baseplate as per EN 1992-4 [2] Sect. 7.2.3. and characteristic resistances are taken from ETA-20/0867 [9].

Verification for steel failure on fastener:

The interaction between tension and shear steel failure on the most unfavorable fastener must be verified (in this design example, anchor 2) according to the following quadratic relationship:

$$\left(\frac{N_{Ed}}{N_{Rd,s}}\right)^2 + \left(\frac{V_{Ed}}{V_{Rd,s}}\right)^2 \leq 1 \quad \text{EN 1992-4, eq. (7.54)}$$

where  $N_{Ed}$  and  $V_{Ed}$  are the design tension and shear loads on the fastener, and  $N_{Rd,s}$  and  $V_{Rd,s}$  are the related design tension and shear resistances. According to the calculations shown in [Sections 5.4.5](#) and [5.4.6](#):

$$\left(\frac{7.5}{36.7}\right)^2 + \left(\frac{8.4}{20.5}\right)^2 = 0.21 \leq 1 \quad \text{verification fulfilled} \checkmark$$

Verification for failure modes other than steel failure:

The interaction between tension and shear failure across all the other failure modes must be verified considering either or the other of the following two relationships:

$$\left(\frac{N_{Ed}}{N_{Rd,i}}\right)^{1.5} + \left(\frac{V_{Ed}}{V_{Rd,i}}\right)^{1.5} \leq 1 \quad \text{EN 1992-4, eq. (7.55)}$$

$$\left(\frac{N_{Ed}}{N_{Rd,i}}\right) + \left(\frac{V_{Ed}}{V_{Rd,i}}\right) \leq 1.2 \quad \text{EN 1992-4, eq. (7.56)}$$



where  $N_{Ed}$  and  $V_{Ed}$  are the design tension and shear loads on the fasteners, and  $N_{Rd,i}$  and  $V_{Rd,i}$  are the related design tension and shear resistances across all failure modes, and the largest value of the ratios  $N_{Ed}/N_{Rd,i}$  and  $V_{Ed}/V_{Rd,i}$  must be considered. According to the calculations shown in [Sections 5.4.5](#) and [5.4.6](#):

$$\left(\frac{15.1}{27.7}\right)^{1.5} + \left(\frac{13.4}{20.1}\right)^{1.5} = 0.95 \leq 1 \quad \text{verification fulfilled} \checkmark$$

#### 5.4.8. Alternative Hilti anchors suitable for the application

Alternative Hilti anchors which can be suited for this project requirement is defined in Table 5.6.

Table 5.6: Anchor properties

|          |                           |                             |        |  |
|----------|---------------------------|-----------------------------|--------|--|
| Option 1 | Type of anchor            | Mechanical                  |        |  |
|          | Specification of anchor   | HST4                        |        |  |
|          | Diameter of anchor        | $d$                         | 12 mm  |  |
|          | Effective embedment depth | $h_{ef}$                    | 60 mm  |  |
|          | Nominal embedment depth   | $h_{nom}$                   | 69 mm  |  |
| Option 2 | Type of anchor            | Chemical                    |        |  |
|          | Specification of anchor   | HIT-HY 200 A/R V3+HAS-U 5.8 |        |  |
|          | Diameter of anchor        | $d$                         | 10 mm  |  |
|          | Effective embedment depth | $h_{ef}$                    | 135 mm |  |
| Option 3 | Type of anchor            | Chemical                    |        |  |
|          | Specification of anchor   | HVU2 capsule + HAS-U 5.8    |        |  |
|          | Diameter of anchor        | $d$                         | 10 mm  |  |
|          | Effective embedment depth | $h_{ef}$                    | 135 mm |  |

## 6. Conclusion

In reference to the development in modern construction and rapid growth in the use of timber to concrete connections in hybrid structures, retrofitting applications etc., design and correct implementation are essential for structural integrity. This handbook includes an overview of the connections, design methods and suitable post-installed anchors of the current Hilti portfolio. Depending on the application, loading and other boundary conditions, the suitable anchor can be selected and installed with the help of relevant properties and IFUs for installation as covered in this book. Timber to concrete connections enables architects and engineers to create innovative designs that leverage the benefits of both the materials, timber and concrete, i.e., strength, flexibility, sustainability, lightweight, aesthetic appeal etc. It also allows a wide range of applications and helps in faster and ease of construction which makes a preferred choice in both new construction and retrofitting projects by the engineers.

## 7. Reference projects

### 7.1. Headquarters Umweltbank Nuremberg, Germany

UmweltHaus is the new headquarter of UmweltBank AG in Nuremberg. The new 13-storey building with a gross floor area of around 25,000 m<sup>2</sup> was designed by the architectural firm Spengler Wiescholek and is being constructed using the timber hybrid construction method with minimum concrete and as much timber sections as possible. UmweltHaus will not only serve as the headquarters for Umweltbank but will also lease office space to other companies as well as commercial space for retail on the ground floor that would be suitable for specialty shops such as an organic market.

#### Problem statement and objective

UmweltHaus (mainly the load-bearing structures; beams and columns etc.) is being constructed using approximately 760 m<sup>3</sup> of beechwood and 130 m<sup>3</sup> of spruce glulam. The window parapet sections will be built with approximately 200 m<sup>3</sup> of cross laminated timber. The glulam components are used for the columns on the upper floors, while the beechwood elements are being installed on the lower floors that are subjected to higher loads. The beams support a timber-concrete composite ceiling system (Fig. 7.1) consisting of prefabricated ribbed elements and a layer of in-situ concrete subsequently applied on site. In total, the project will require 3,000 m<sup>3</sup> of timber to be installed. Timber elements are prefabricated and the connection with concrete is done on-site using post-installed anchors.



a) UmweltBank's UmweltHaus building in Nuremberg (Source: Spengler Wiescholek Architektur // Stadtplanung | bloomimages)



b) Connection of timber column with steel brackets and post-installed anchors

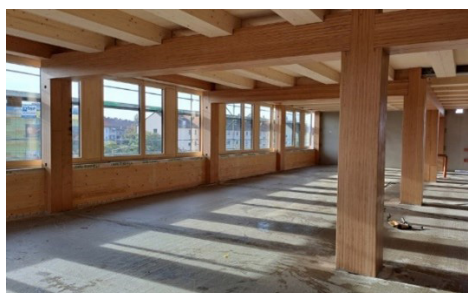

c) The large beechwood supports allow generously proportioned, widely opened spaces (Source: Züblin Timber)



d) The primary structure (beam-column) supports timber-concrete composite ceiling system (Source: UmweltBank AG)

Fig. 7.1: Jobsite images for timber-concrete hybrid construction at UmweltHaus



### Approach followed (design and solution)

Typical solutions for timber to concrete fastening include various connections such as shear and tension plates, holdowns and angle brackets (Fig. 7.2). In this project, the structural engineer requested post-installed anchors with ETA approval. Hilti offered suitable solutions right at the time of discussion and design was submitted using PROFIS Engineering for design verifications.



Fig. 7.2: Timber column to concrete connection with steel brackets and post-installed anchors at jobsite

### Design methods used

**Post anchoring in bridge deck** – Design according to EN 1992-4 [2].

### Total solution and benefits:

**Software:** PROFIS Engineering software was used for design calculation.

**Hardware:** the Hilti post-installed HUS4-H screw anchor was used in combination with cordless impact wrench SIW 8-22.

**Services:** Hilti Technical experts supported in the design process.

**Training:** Hilti provided training for the installers and offered consultation to supervisors regarding the quality of the installation.

## Acknowledgements

The contribution of the following people in the Hilti world in creating this handbook for timber-to-concrete connections. The below included list cannot be complete, because several people have contributed is greatly acknowledged.

### **Content and Reference projects**

Jörg Appl, Hans Henning Artmann, Giorgio Barono, Agamoni Das, Mariia Gavrilina, Giovacchino Genesio, Philipp Grosser, Xavi Moix-Vallribera, Lars Taenzer.

## References

- [1] P. Grosser, A. Echterbruch and M. Reimann, Hilti coupler wood (HCW); Timber-to-concrete connections using HCW and post-installed anchors, May, 2023.
- [2] EN 1992-4:2018: Eurocode 2 - Design of concrete structures - Part 4: Design of fastenings for use in concrete, Brussels: CEN, 2018.
- [3] EN 1995-1-1:2004: Eurocode 5 - Design of timber structures - Part 1-1: General -Common rules and rules for buildings, Brussels: CEN, 2008.
- [4] S2C Handbook: Steel to concrete connections using Post-installed systems, Schaan: Hilti Corporation, 2024.
- [5] Fastening Technology Manual; Version 2023, Hilti Corporation, 2023.
- [6] ETA-21/0878: HST4-R Torque-controlled expansion anchor, for use in concrete: sizes M8, M10, M12, M16 and M20, Marne-la-Vallée: CSTB, 31.10.2024.
- [7] CEN/TR 17079: Design of fastenings for use in concrete - Redundant nonstructural systems, Brussels: CEN, September, 2018.
- [8] ETA-21/0480: Hilti metal expansion anchor HST2 V3, Berlin: DIBt, 31.10.2024.
- [9] ETA-20/0867: Hilti screw anchor HUS4, Mechanical fastener for use in concrete, Berlin: DIBt, 11.02.2025.
- [10] ETA-19/0601: Bonded fastener and bonded expansion fasteners for use in concrete, Berlin: DIBt, 29.01.2024.
- [11] ETA-16/0515: HVU2, Bonded fasteners and bonded expansion fasteners for use in concrete, Berlin: DIBt, 14.09.2023.
- [12] EN 1990:2002+A1: Basis of structural design, Brussels: CEN, 2005.
- [13] EN 1991-1-1: Eurocode 1: Actions on structures - Part 1-1: General actions -Densities, self-weight, imposed loads for buildings, Brussels: CEN, 2002.
- [14] Eurocode 8: Design of structures for earthquake resistance -Part 1: General rules, seismic actions and rules for buildings, Brussels: CEN, 2004.

## Notes

## Notes

## Notes





Hilti Aktiengesellschaft  
9494 Schaan, Liechtenstein  
P +423-234 2965

[www.facebook.com/hiltigroup](https://www.facebook.com/hiltigroup)  
[www.hilti.group](https://www.hilti.group)