





HAP 2.5 Hoist Anchor Plate

Product Technical Datasheet
Steel-to-concrete
Update: Jun 25



HAP 2.5 Hoist Anchor Plate

Hoist Anchor Plate with 2.5T WLL capacity for elevator shaft operations

| Anchor version | Benefits |
|---|---|
|  <p data-bbox="715 607 863 696">HAP 2.5 + HST4/HST3</p> | <ul style="list-style-type: none"> - 2.5T WLL capacity according to Machinery Directive 2006/42/EC. - Anchorage of hoist to be designed with PROFIS Engineering suite for cracked and uncracked concrete, $\geq C20/25$, according to EN1992-4 - Type-examination certificate issued by Liftinstituut B.V. - Recommended and designed for anchorage with anchors: <ul style="list-style-type: none"> • HST4 M12x105 ($h_{nom}=69$ mm) • HST3 M12x115 ($h_{nom}=80$ mm) • HUS4-H 10x110 ($h_{nom3}=85$mm) - Delivered pre-assembled (one piece) with included anchor options available: HAP 2.5 + Anchors (4xHST4, 4xHST3 or 4xHUS4). - Lightweight: One person installation possible at overhead position total weight < 3Kg. - No rotation of hook point allowed preventing swiveling. |
|  <p data-bbox="735 1178 842 1267">HAP 2.5 + HUS4-H</p> | <ul style="list-style-type: none"> - Large hooking area for easy engagement. Hook point: $\varnothing > 90$mm. - Compact design for narrow spaces: rigid height < 56mm. - Printed IFU on the product for immediate clarification. - < 45° loading allowed in all directions. |



Application

HAP 2.5 is designed to be used as post installed “master hoist point” for installation and/or maintenance in elevator shafts under static and quasi-static loading. The HAP2.5 can be used with manual or motor hoists and bears a working load up to 2.5 tons in variable directions.



Base material

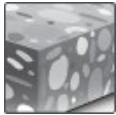

Concrete (uncracked)

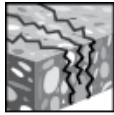

Concrete (cracked)

Load conditions

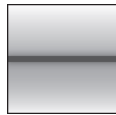

Static/
quasi-static

Drilling, cleaning, setting

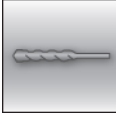

Hammer drilled holes

Other information



PROFIS
Engineering
Software

Instructions for use

The instructions for use can be viewed using the link in the instructions for use table or the QR code/link in the Hilti webpage table.

Instructions for use (IFU)

| Anchor size | HST3 M12 | HST4 M12 | HUS4 M10 |
|---------------|----------|-----------------------------|----------|
| HAP | | IFU HAP 2.5 | |
| Anchor Tester | | IFU HAT 28 | |

Link to Hilti Webpage

| HST4 | HUS4-H | HST3 | HAP 2.5 |
|----------------------|------------------------|----------------------|-------------------------|
| | | | |

Fastener special dimensions

HAP 2.5 dimension

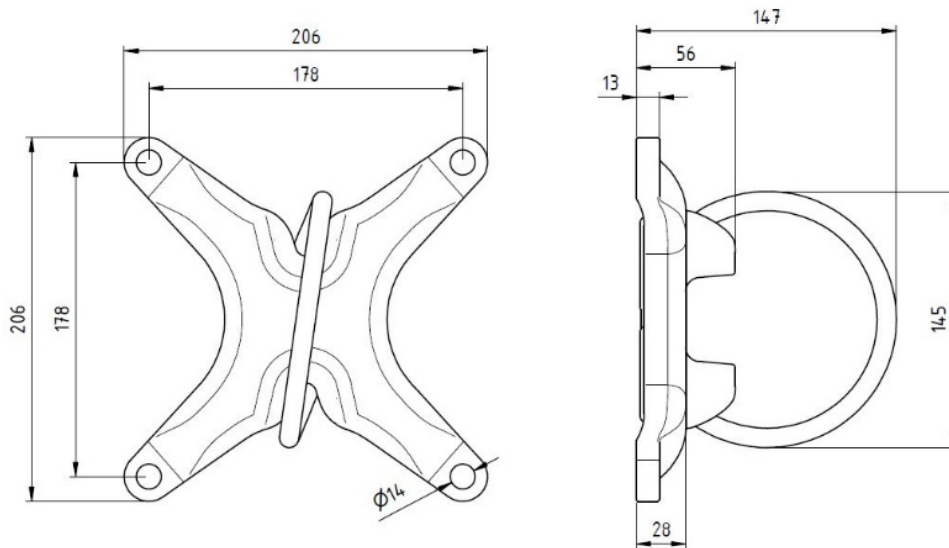

HST4 and HST3

| Anchor type | | HST4 M12 | HST3 M12 |
|---------------------------|-----------------|----------|----------|
| Recommended anchor length | L [mm] | 105 | 115 |
| Outer diameter of washer | $d_w \geq$ [mm] | 24 | |

HST4 M12

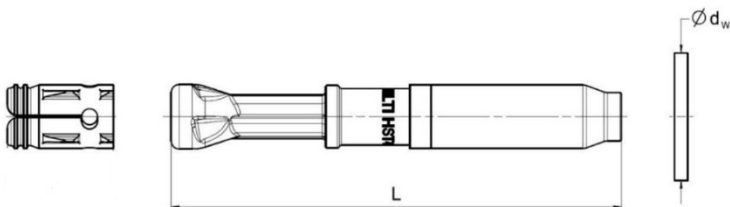

HST3 M12

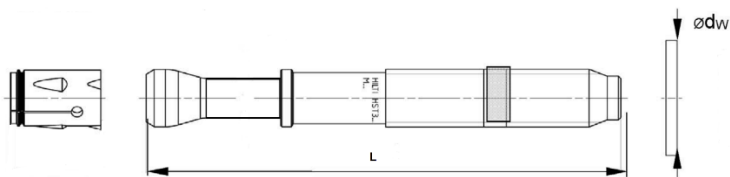

HUS4-H

| Anchor size | | HUS4 H 10 |
|--------------------------------|------------|-----------|
| Outer diameter of screw thread | d_t [mm] | 12,70 |
| Diameter of integrated washer | d_i [mm] | 20,50 |
| Recommended anchor length | L [mm] | 110 |

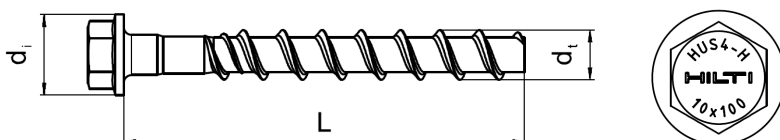

Warning

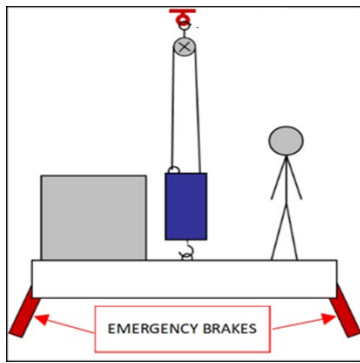

**Men riding (Car-top Lift-installation Method)
(worker and material on top of the cabin)**

In case the main hoist point fails, the platform falls ~0.3m until the elevator safety-gears will automatically activate bringing the elevator cabin to a complete stop. Emergency brakes need to be activated.

HAP Working Load Limitation (WLL)^{a) b)}

| | |
|--|---------------------|
| | Load type |
| | Single Point |
| | |
| 45° < α < 135° WLL_{total} [metric ton] | 2,5 |

a) In accordance with machinery safety directive 2006/42/EC the following working coefficients were implemented:

- Working coefficient of all metal components: $\gamma = 4$
- Working coefficient of the cables: $\gamma = 5$

b) Data valid (hoist only) for static loading and fatigue cycling loading for the number of cycles, $1000 < \text{cycles} < 10000$, under pure tension or up to a load inclination of 45°. see test report TWU72/18 Anchors must be verified separately. For further details please contact you Hilti representative,

Design of anchorage

HAP 2.5 is designed to be used as hoist point for lifting loads under variable directions in elevator installation or maintenance. The design of the anchor connection of the HAP 2.5 must be verified for varying load conditions (varying directions, dynamic effects, etc.). The below examples are of the anchor connection of the HAP 2.5 and have been designed according to ultimate load cases: a concrete anchor can only be considered as suitable for use with the HAP 2.5 hoist point if the approved anchor satisfies the following load scenarios (e.g. by PROFIS Engineering calculation) with EN1992-4 calculation method. It has to be done in accordance with the relevant codes/ETAs for each application case separately. In case of different design conditions a new calculation should be performed.

Static and quasi-static loading based on ETA-21/0878 (HST4), ETA 98/0001 (HST3) and ETA-20/0867(HUS4-H).Design according to EN 1992-4

All data in this section applies to: (Data for max 2.5 t WLL capacity applies to HAP 2.5 only when)

- Correct setting (See setting instruction)
- For a group anchor (see the anchor arrangement below)
- Concrete C20/25, Cracked concrete
- Hammer drilled holes
- No edge distance influence
- Embedment depth, as specified in the table of this section
- The anchor calculation is based on a rigid baseplate assumption
- No shock loading; dynamic amplification factor γ_{dyn} up to 1,8 (EN 1991-1-1)

For specific design cases refer to [PROFIS Engineering](#).

Load Case 1 – Pure tension 90° angle

Action: $N = 2,5t (WLL) \times 1,8 (\gamma_{dyn}) = 45 \text{ kN}$

Anchor arrangement

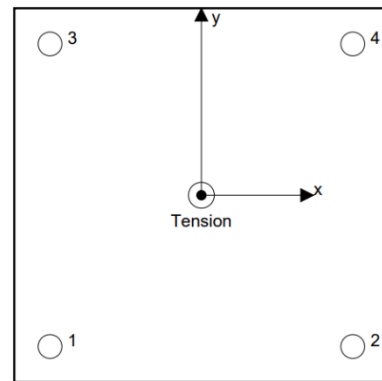
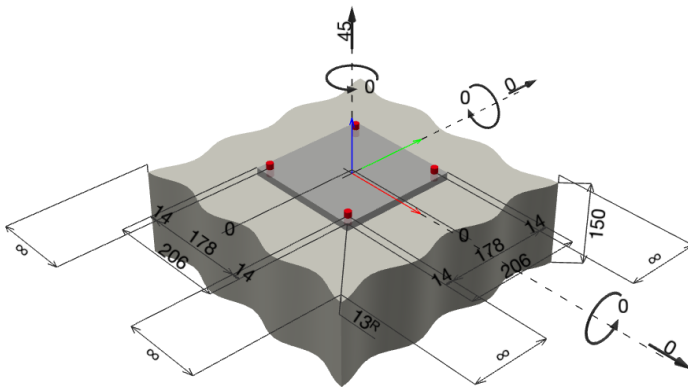

Design resistance - HST4 M12 ,HST3 M12 and HUS4-H M10

| Anchor size | | | HST4 M12 | HST3 M12 | HUS4-H M10 | |
|------------------------------------|------------------|----------|-------------|----------------------------|----------------------------|-----------------------------|
| Effective anchorage depth h_{ef} | | | 60 mm | 70 mm | 68 mm | |
| Nominal embedment depth h_{nom} | | | 69 mm | 80 mm | 85 mm | |
| Load direction | Anchor reactions | | Group force | Max. Util. Anchor | | |
| Tension N_{Rd} | Anchor 1 | 11.25 kN | 45 kN | 93% (concrete breakout) | 99% (concrete breakout) | 100% (concrete breakout) |
| | Anchor 2 | 11.25 kN | | | | |
| | Anchor 3 | 11.25 kN | | | | |
| | Anchor 4 | 11.25 kN | | | | |

Load Case 2 – Combination Tension & Shear 45° angle

Action: $N = N_t \times \sin 45^\circ = 32\text{kN}$, $V_x = N_t \times \cos 45^\circ = 32\text{kN}$

Anchor arrangement

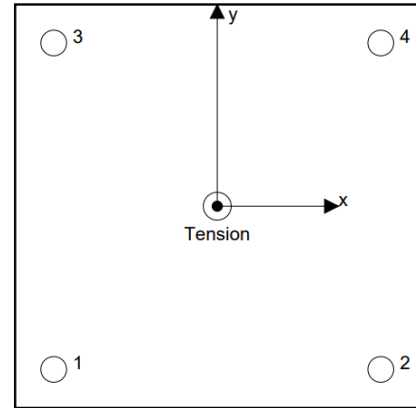
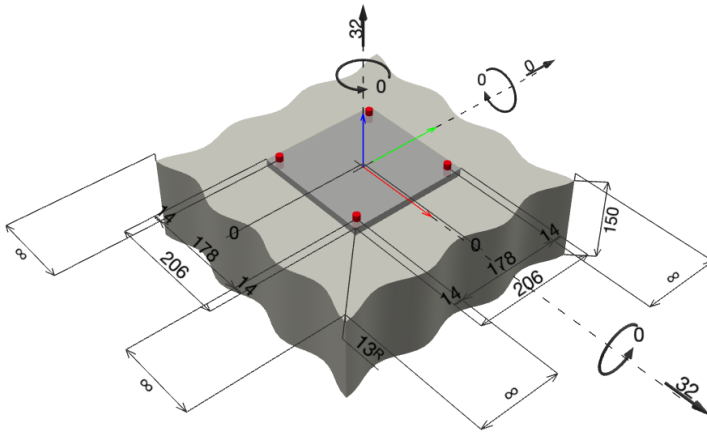

Design resistance - HST4 M12 ,HST3 M12 and HUS4-H M10

| Anchor size | | | | HST4 M12 | HST3 M12 | HUS4-H 10 | |
|---------------------------|------------------|-----------|------|-------------|---|---|---|
| Effective anchorage depth | | h_{ef} | | 60 mm | 70 mm | 62.9 mm | |
| Nominal embedment depth | | h_{nom} | | 69 mm | 80 mm | 85 mm | |
| Load direction | Anchor reactions | | | Group force | Max. Util. Anchor | | |
| Tension N_{Rd} | Anchor 1 | 8 kN | - | 32 kN | Combination: Concrete 65% Steel 14% | Combination: Concrete 71% Steel 15% | Combination: Concrete 79% Steel 13% |
| | Anchor 2 | 8 kN | | | | | |
| | Anchor 3 | 8 kN | | | | | |
| | Anchor 4 | 8 kN | | | | | |
| Shear V_{Rd} | Anchor 1 | | 8 kN | 32 kN | | | |
| | Anchor 2 | | 8 kN | | | | |
| | Anchor 3 | | 8 kN | | | | |
| | Anchor 4 | | 8 kN | | | | |

Setting information

Setting parameters

| Parameter | | | HAP 2.5 |
|---------------------------------|------------|------|--|
| Minimum base material thickness | h_{\min} | [mm] | According to technical data of applied anchors |
| Spacing (Hoist Anchor Plate) | s | [mm] | 178 |
| Edge distance | c | [mm] | According to technical data of applied anchors ^{a)} |

^{a)}For smaller edge distances the designs should be verified with appropriate modelling and calculations. Please see [Profis Engineering](#)

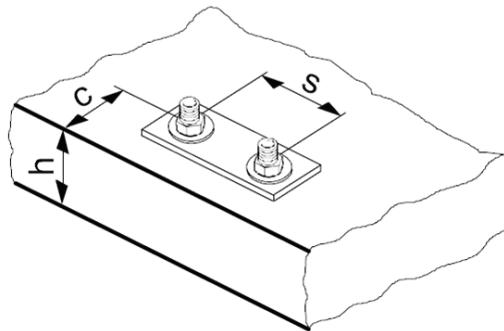

Inspection criteria

Caution: The attachment point must be in a good operating condition and undamaged. Broken wires, signs of corrosion, visible distortions or deformations are unacceptable.

Caution: The shaft ceiling, particularly the concrete, must be in sound condition. Any visible cracking, blow out or signs of corrosion are unacceptable.

Caution: Do not use an attachment point which has an unreadable or missing identification label.

Onsite qualification

HAP 2.5 is designed for temporary & permanent application under dry indoor conditions.

Recommended tools to do onsite qualification: Anchor Tester HAT 28-E (#386372) with HAT Kit HAP 2.5 (#2301103).

Installation instructions

Install the anchors according to the Hilti Instruction for use. The HST4 M12 with $h_{nom} = 69\text{mm}$ and HUS4-H/HUS3-H size 10 with $h_{nom3} = 85$ are recommended as per this document. Ensure HAP 2.5 is correctly installed, according to the Instruction for use of the HAP 2.5.

Set up the HAT 28E according to the manual provided with the anchors tester (see the Instructions for Use). Set bridge legs to right heights. (*Image 1*). Then, connect the ring bolt adapter to steel wire rope. Always use the provide steel disc as shown in *Image 2*. Testing without the disc accessory could result in damaging the wire rope of the HAP 2.5. A HAP 2.5 with a bent wire rope is not safe for use.



Image 1



Image 2

- 1) Connect HAT 28-E with ring bolt adapter and make sure the bridge of the tester is parallel to the concrete surface as well as to the HAP 2.5 base (*Image 3*). Check if the baseplate can be moved relative to the concrete. The HAP 2.5 baseplate needs to be firmly in contact with the concrete. Turn crank clockwise until the legs are in contact with base material, bringing the system to firm starting position (avoid commencing the proof loading stage). Ensure testing forces act parallel to axis of anchors and to the legs of tester. HAP 2.5 must remain plumb in the both parallel and perpendicular direction of the tester.

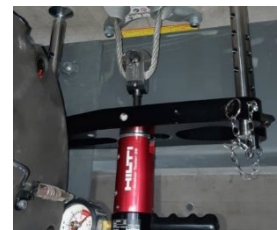

Image 3

- 2) Set the red handle of the analogue gauge to zero in order to be able to start the measurement. (*Image 4*).







Image 4

- 3) Hold the HAT 28-E by the grip while increasing the load of the HAP 2.5 by turning the crank (or with spanner wrench on hexagon nut on top of tester) in a clockwise direction. Increase the load until desired proof load is attained. *Image 5*. Do not exceed the maximum allowable load of the tester of 30kN!



Image 5

| | |
|---|--|
| <p>4) Hold the HAT 28-E by the grip while increasing the load of the HAP 2.5 by turning the crank (or with spanner wrench on hexagon nut on top of tester) in a clockwise direction. Increase the load until desired proof load is attained. <i>Image 5</i>. Do not exceed the maximum allowable load of the tester of 30kN!</p> |  <div data-bbox="1262 320 1417 371" style="border: 1px solid black; padding: 2px; text-align: center;">Image 5</div> |
| <p>5) Keep the proof load applied to the HAP 2.5 for the required time. Do not keep retightening if the loading relaxes during this time. The displacement is not allowed to increase in this time.</p> |  |
| <p>6) Release the load by turning the crank counterclockwise (<i>Image 6</i>)</p> |  <div data-bbox="1262 846 1417 898" style="border: 1px solid black; padding: 2px; text-align: center;">Image 6</div> |
| <p>7) Remove HAT 28-E and ring bolt adapter.</p> | |
| <p>8) Perform visual check on HAP 2.5 and base material (<i>Image 7</i>). Check if the baseplate is still firmly pressed to the concrete. If baseplate is loose, re-tight anchors and repeat procedure from the beginning.</p> <p>We recommend <u>NOT TO USE</u> the tested HAP 2.5 when:</p> <ul style="list-style-type: none"> • The baseplate is loose even after repeated test procedure. • If the basematerial shows cracks during and or after the test around the HAP 2.5 (this could be a sign of an overload of the capacity of the concrete) • If the HAP is damaged or deformed or the wire rope. <p>In these cases set a new point in a different position and repeat procedure from the beginning.</p> |  <div data-bbox="1262 1305 1417 1357" style="border: 1px solid black; padding: 2px; text-align: center;">Image 7</div> |
| <p>9) If the testing was successful mark or label the HAP 2.5 according to your requirements.</p> |  |